

RUNPOTEC®

STRONGEST CABLE PULLING

PRODUCT CATALOG

PRODUCTS & INNOVATIONS

2023



CABLE PULLING SYSTEM

GF3

GLASS FIBER Ø 3 MM

RG7 - Guiding head
with front thread
incl. swivel and
kink protection



Integrated digital
meter counter - m/ft

INSTEAD OF € 199,00

€ **169,00**
plus tax

GF3 Glass Fiber 30 m – Introductory price
RUNPOTEC item no.: 10193





RG7 - guiding head with front thread incl. swivel and kink protection

Integrated digital meter counter - m/ft



Accessory box (16-parts)



INTRODUCTORY PRICE

GF3 - fiber glass rod Ø 3 mm - 30 m

GF3 - cable pulling system incl. digital meter counter ft/m, fiber glass rod Ø 3 mm with RG7 - guiding head with front thread incl. swivel and kink protection, 16 piece accessories, easy service access - just open one screw, automatic guide back protection. Jobsite capable, splash water & dust proof
Optimal field of application: pipe-Ø 10 mm - 50 mm

For more information see product videos.

INSTEAD OF € 199,00

€ **169,-**
plus tax

GF3 - 30 m - Introductory price
RUNPOTEC Item no. 10193



PROMOTION DESCRIPTION

XB 500 - X BOARD profi calbe roller

Universal profi cable drum winder and unwinder for all types of cables and pipes (conductors, cable rings, cable drums, conduits, ropes and cable drums). It can be loaded up to 800 kg and is suitable for almost any type of drum. Especially suitable for damaged cable drums. The height-adjustable cover is perfectly designed to secure loose cables, cable rings or pipes, thus preventing uncontrolled cable unwinding.

For more information see product videos.

INSTEAD OF € 265,00

€ **234,-**
plus tax

X BOARD XB 500 - promotional price
RUNPOTEC Item no. 10136



PROMOTION DESCRIPTION

RM35 - cable length measuring device + **XB 300** - X BOARD profi cable roller

- 1 x RM35 digital cable length measuring device incl. accessories and system case (incl. 2x mountingplate)
 - 1 x XB 300 - X BOARD profi cable roller
- Universal cable drum rewinder and unwinder (also for damaged cable drums), loadable up to 300 kg

For more information see product videos.

INSTEAD OF € 519,90

€ **379,-**
plus tax

RM35 - X BOARD XB 300 - offer
RUNPOTEC Item no. 11143





RUNPOLIFTER 4500 - cable drum lifter

The RUNPOLIFTER 4500 is a foldable cable drum lifter that is capable of lifting drums with a maximum diameter of 1600 mm and a maximum weight of 4500 kg and a max. width of 1250 mm.

For more information see product videos
 Scope of supply:
 1 x Lifting support right, 1 x Lifting support left
 1 x Drum shaft, 2 x centring cones



Foldable, only 22 kg per lifting support
 Compact - easy transportation

Lifter Sets	Shaft length	Item no.	Rec. trade price
Lifter 1150	1150 mm	10162	2610,00 €
Lifter 1350	1350 mm	10163	2650,00 €
Lifter 1600	1600 mm	10164	2690,00 €

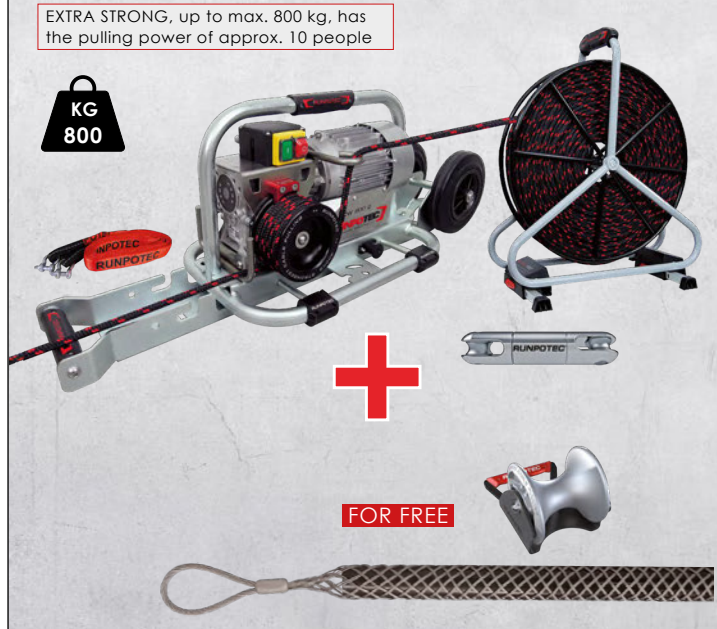

EXTRA STRONG, up to max. 800 kg, has the pulling power of approx. 10 people

PROMOTION OFFER!

Buy **1x capstan winch + 1x pulling rope + 1x connection swirl**, get **1x Cable pulling grip + 1x Cable guide roller – shaft** for free!

- CW 800 E capstan winch incl. trolley mounting rail and strap for horizontal cable pulling (230 V / 50 Hz - 0,75 kWh / 5,1 A)
- Polyester cable pulling rope incl. steel reel
- Connection swirl with swivel Ø 30 mm
- Cable pulling grip with loop, made of high quality, galvanised steel double weave

Further information is available at www.runpotec.com or in the product video



Quality check

RUNPOTEC products are checked at several stages for

- Breaking load
- Material quality
- Material fatigue
- Mechanical stress
- Functional ability

A large part of the RUNPOTEC products are made of stainless steel

- High stainless steel quality
- Precise processing
- High load capacity





PROMOTION -DESCRIPTION

GF3 Glass fiber rod Ø 3 mm - 30 m + **RC2** Inspection camera - 30 m

- 1 x GF3 - 30 m, with integrated digital meter counter - m/ft., cable pulling system, optimal for pipe diameter Ø 10 - 50 mm
- Total breaking load 130 kg (fiberglass rod incl. kink protection)
- 1 x RC2 Inspection camera with 30 m cable
- Field of application in combination with GF3: pipe inspections over long distances up to 50 m - as of 14 mm inner diameter

For more information see product videos

INSTEAD OF € 765,00

€ 659,-

plus tax

GF3 - 30 m - RC2 - 30 m - offer
RUNPOTEC Item no. 11146



PROMOTION-DESCRIPTION

RUNPOSTICKS - Comfort-package + **RC2** Inspection camera - 30 m

- 1 x RUNPOSTICKS - Comfort-package
- Field of application: suspended ceilings, cable ducts, hollow walls, underfloor shafts usw... Content: 19-parts
- 1 x RC2 - Inspection camera with 30 m cable
- Memory function / documented evidence - photo, video
- Battery operation up to 6 hours, protection class IP 67

For more information see product videos

INSTEAD OF € 705,00

€ 643,-

plus tax

RC2 - 30 m - RUNPOSTICKS - offer
RUNPOTEC Item no. 11137



PROMOTION-DESCRIPTION

GF4.5 fiberglass rod Ø 4,5 mm - 50 m + **RC2** Inspection camera - 50 m

- 1 x GF4.5 - fiberglass rod Ø 4,5 mm - Profi Set - 50 m
- Field of application: optimal for pipe-Ø 30 - 80 mm
- 1 x RC2 - Inspection camera with 50 m cable
- Field of application: See description above

For more information see product videos

INSTEAD OF € 914,00

€ 789,-

plus tax

GF4.5 - 50 m - RC2 - 50 m - offer
RUNPOTEC Item no. 11140



NEWS - SPECIAL OFFERS - INFORMATION	
GF3 - Glass Fiber Ø 3 mm - Cable pulling system	2
XB 500 - X BOARD - Profi-cable roller	2
RM35 - Digital cable length measuring device + XB 300 - X BOARD -Profi-cable roller	2
RUNPOLIFTER 4500 - cable drum lifter CW 800 E capstan winch - special offer Quality check	2
RC2 Inspektion-camera - special offers	4
CABLE PULLING SYSTEMS	
Cable lubricant GEL FOAM SPRAY LIQUID	19
RUNPO 5 - Profi cable pulling system Ø 5,3 mm	20
RUNPOSTICKS - Standard- and comfort package	22
RP 1 - Cable pulling rod Ø 4 mm	24
GF3 - Glass Fiber Ø 3 mm - Cable pulling system	25
RT 2008 - Mechanical cable pulling tool	28
MET 4 - Steel fish tape Ø 4 mm	29
Cable pulling loop - hook (quick connection) RTG 6 thread	30
Cable pulling grip - RTG Ø 6 mm thread loop	31
Cable diameters - Summary table - Information page	33
GF4.5 - Fiberglass rod Ø 4,5 mm - Cable pulling system	34
GF6 - Fiberglass rod Ø 6 mm - Cable pulling system	37
GF7.5 GF9 - Fiberglass rod Ø 7,5 / 9 mm - Cable pulling system	41
GF11 - Fiberglass rod Ø 11 mm - Cable pulling system	44
GF15 - Fiberglass rod Ø 15 mm - Cable pulling system	46
Flexible leading head-set	40
CW 800 E - Capstan winch for horizontal cable pulling	48
Polyester cable pulling rope - incl. steel reel	50
Metal spiral - Ø 4 mm Nylon fish tape - Ø 3 – 4 mm	53
INSPECTION SYSTEMS - MEASURING DEVICES - RUNPOTEC SYSTEM-CASE	
RC2 - Inspection-camera	16
RM35 - Digital cable length measuring device	6
RM80 - Laser distance meter	52
RUNPOTEC system case	10
CABLE ROLLER SYSTEMS	
XBOARD XB300 - Profi-cable roller Multifunction mandrel	8
XBOARD XB500 - Profi-cable roller	11
PRO 530 PRO 670 - Cable drum roller	12
AS 900 - Roll-off rails	13
RUNPOLIFTER 4500 SET - Cable drum lifter	14
Drum samples - for RUNPOLIFTER 4500 SET - Information page	15
Cable guide roller	51
RICE LIST - GTC - SPECIAL OFFERS	
Price list	54
GTC - General terms and conditions	58
Special offers - RUNPOSTICKS - Cable pulling loop - RUNPO 5 - RM35	59

RM35 Digital cable length measuring device



CALIBRATABLE



Foldable



Jobsite capable:
Splash water & dust proof,
shock- and break-proof

Versatile use with cables,
single conductors, ropes,
pipes of Ø 2 mm – 32 mm

Compatible with all unwinding
systems

Battery life in continuous
operation 100 hrs. (without
backlighting)

RUNPOTEC system case



W-BOX | Sortimo COMPATIBLE

The **RM35** is a digital cable length measuring device with which cables, single wires, ropes, pipes or hoses with a diameter of Ø 2 mm to Ø 32 mm can be measured precisely. It is splash-proof and dust-proof, extremely shock-resistant and therefore ideally suited for the construction site. The RM35 accessories included are stowed away in the RUNPOTEC system case, which is compatible with Sortimo. The strap with clip system makes it easy to connect RM35 to the X BOARD XB 300 or XB 500 cable unwinding system. If the belt is connected to the anchor pad with a clip system, the RM35 is compatible with all conventional unwinding systems.

Display with extensive application possibilities

- 1 Current counter value (pos./neg.), max. measuring distance 99999,99 m
- 2 Countdown, e.g. for repeated cable cutting or drum residual value determination (initial value 200 m minus unwound length 50 m 1 results in current residual value (150 m) – see actual 3)
- 3 Actual - current remaining value (150 m) from the entered countdown value
- 4 Add current counts (positive/negative) to totals (TOTAL 1/2).
- 5 Cable pull direction display (forward/backward)

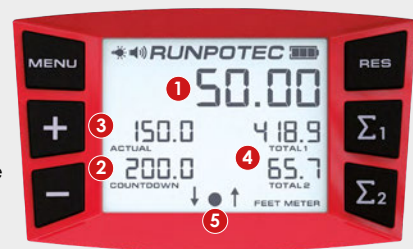

Scope of delivery – RM35 including extensive accessories (Item no. 10172, 10184, 11143)

- A RM35 Digital cable length measuring device
- B RUNPOTEC system case with case insert for RM35
- C Mountingplate RM35
- D Mountingplate system case
- E Belt with clip-system
- F Connecting pad
- G Multi jaws RM35 – round
- H Guide jaws RM35
- I USB-C charger cable



All prices are ex-works 5303 - Thalgau - AUSTRIA - plus statutory taxes and duties. All price information represents non-binding price recommendations. Pricelist 2023. All illustrations are symbol photos. Typing and printing errors reserved.

Application examples









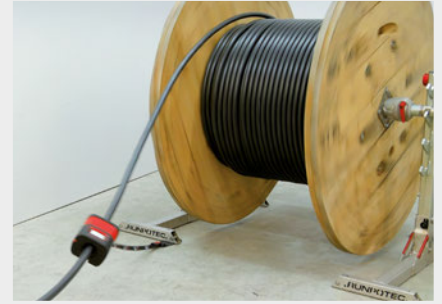





RM35 with belt and clip-system connected to GF4.5 fiberglass rod



RM35 with belt and clip-system connected to X BOARD XB 500



RM35 with RUNPOLIFTER L1600 and 3 x 35 mm² cable

Item	Item no.	Rec. trade price
	<p>RM35 Digital cable length measuring device</p> <p style="text-align: right; color: red;">Introductory price</p>	<p>10172</p> <p>399,90 € 329,00 €</p>
<p>CALIBRATED</p>   <p>Detailed description of the calibration (Test according to module F) can be obtained via the QR-Code or via www.runpotec.com</p>	<p>RM35 Digital cable length measuring device Calibrated incl. test certificate according to module F</p> 	<p>10184</p> <p>469,00 €</p>
	<p>Belt with clip-system and connecting pad To connect with all conventional rolling systems Belt length 1200 mm + connecting pad (2-part) Belt length 2400 mm + connecting pad (2-part)</p>	<p>20706 33,00 € 20714 38,00 €</p>
 <p>Info: Easy changing with 2,5 mm Allen key</p>	<p>Sliding jaw set RM35 – 4-part Spare part for RM35</p>	<p>20707 13,00 €</p>
 <p>Example photo: Interior view</p>	<p>RUNPOTEC system case with case insert for RM35</p>	<p>20708 54,00 €</p>
 <p>Example photo: Without RM35 and system case</p>	<p>Mountingplate – system case Attachment for fastening to the RUNPOTEC System case, with click system for RM35</p>	<p>20739 39,00 €</p>
 <p>Example photo without RM35</p>	<p>Mountingplate RM35 For attachment with screws (not included), with click system for RM35, lockable</p>	<p>20849 19,90 €</p>
  <p>Ø 12 mm Ø 18 mm Ø 6 mm Ø 24 mm</p>	<p>Guide jaws RM35 – 4 parts for high-precision measuring results Guide jaws grey (Ø 12 mm / 18 mm) Guide jaws red (Ø 6 mm / 24 mm)</p>	<p>20738 17,00 €</p>
  <p>from Ø 2 mm – Ø 15 mm adjustable</p>	<p>Multi jaws RM35 – round for high-precision measuring results Cable diameter adjustable by turning from Ø 2 mm - 15 mm</p>	<p>20850 22,00 €</p>
  <p>Width from 3 mm – 15 mm adjustable</p>	<p>Multi jaws RM35 – angular for precision measurement results of duplex cable, LED cable, ribbon cable etc. Adjustable by turning. Width from 3 mm – 15 mm</p>	<p>20851 22,00 €</p>

X BOARD XB 300 Profi-cable roller

VIDEO



XB 300 MANDREL



X BOARD MANDREL
Ø 45 mm, removable for small drums

Now with Clip-system for the RM 35 digital cable length measuring device



KG 300

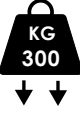

RM35 – digital cable length measuring device COMPATIBLE



The compact **X BOARD – XB 300** is a universal, professional device for winding in/out cables on all small- to mid-sized cable drums and particularly well suited for damaged cable drums. The XB 300 scores with its small, light and flat design, has a diameter of Ø 300 mm and can be loaded up to 300 kg. Six rubberised feet ensure a non-slip and secure standing position. The removable mandrel allows cable drums with different hole sizes to be used. Here also the multi-function mandrel can be attached to unwind loose cable bundles or single wires. For trouble-free and efficient working without the tangled cables. (Multifunction mandrel is not included).

Compatible with the Multifunction mandrel



Possible applications



Multifunction mandrel

Can only be used in combination with X BOARD XB 300 (and XB 500)

VIDEO





XB 300 MANDREL



Telescopic middle mandrel height up to max. 294 mm and a diameter of Ø 72.5 mm

Diameter with unfolded side brackets Ø 430 mm



foldable

The **multifunction mandrel** has been specially developed for the X BOARD XB 300 and XB 500 cable rolling systems. By attaching it to the stainless steel central mandrel and unfolding the 4 side brackets, loose cable bundles or individual wires can also be rolled. Optimum area of application: rolling of loose cable bundles or individual wires up to a max. height of 294 mm and a max. diameter of 430 mm

Possible applications



Item	Item no.	Rec. trade price
	10137	114,40 €
<p>X BOARD – Profi-cable roller XB 300 – Ø 300 mm load bearing capacity 300 kg incl. X BOARD mandrel and lateral clip system (for connection with RM35 cable length measuring device)</p>	20696	53,00 €
	20632	10,00 €
<p>X BOARD mandrel for X BOARD XB 300 and XB 500</p>		



Application examples

OFFER DESCRIPTION

XB 300 + multifunction mandrel-set

INSTEAD OF € 167,40

€ **148,-**

plus VAT.

XB 300 - multifunction mandrel-set - offer RUNPOTEC item no. 10174



W-BOX | Sortimo COMPATIBLE

OFFER DESCRIPTION

XB 300 – complete-set incl. multifunction mandrel + system case

INSTEAD OF € 221,40

€ **189,-**

plus VAT.

XB 300 - complete-set - offer RUNPOTEC item no. 10170



W-BOX | Sortimo COMPATIBLE

OFFER DESCRIPTION

RUNPO 5 + XB 300 – multi-set incl. multifunction mandrel + system case

1 x RUNPO 5 - 30 m, triple twisted, total breaking load 270 kg

1 x XB 300 - incl. multifunction mandrel

The multifunction mandrel has been specially developed for the X BOARD XB 300 and XB 500 cable rolling systems.

INSTEAD OF € 383,40

€ **305,-**

plus VAT.

RUNPO 5 - 30 m - XB 300 - multi-set - offer RUNPOTEC item no. 10171

VIDEO



RUNPO 5

RUNPOTEC SYSTEM CASE

W-BOXX® | Sortimo® COMPATIBLE

Stackable with fast click system



RUNPOTEC system case with UNIVERSAL, RC 2 Inspektionskamera, RT 2008 and RUNPOMETER RM 35 case insert is perfect for storing and transporting of the previously mentioned RUNPOTEC products. One advantage is the fast click system, which allows the boxes to be connected to each other without effort and disconnected again at the push of a button. The boxes are easily stackable thanks to the quick click system. The W-BOXX can be seamlessly integrated into the Sortimo Globelyst system. The high-quality and lightweight W-BOXX made of PP plastic is impact and shock resistant and splash-proof.

UNIVERSAL case insert



symbol photo without content

RC2 Inspection-camera case insert



symbol photo without content

RT 2008 case insert



symbol photo without content

RM 35 case insert



symbol photo without content

Item		Item no.	Rec. trade price
		RUNPOTEC system case with case insert for RT 2008	20611 54,00 €
		RUNPOTEC system case with case insert for RC2 Inspektions-kamera	20612 54,00 €
		RUNPOTEC system case with UNIVERSAL case insert For XB 300 + multifunction mandrel + RUNPO 5 + small parts	20613 54,00 €
		RUNPOTEC system case with case insert for RM 35 For RM 35 including accessories	20708 54,00 €

All prices are ex-works 5303 - Thalgau - AUSTRIA - plus statutory taxes and duties. All price information represents non-binding price recommendations. Pricelist 2023. All illustrations are symbol photos. Typing and printing errors reserved.

X BOARD XB 500 Profi-cable roller



RM35 – digital cable length measuring device
 ● COMPATIBLE



X BOARD MANDREL
 Ø 45 mm, removable for small drums

Now with Clip-system for the RM 35 digital cable length measuring device



Compatible with the multifunction mandrel



The **X BOARD XB 500** is a universal professional cable drum winder and unwinder for all types of cables and pipes (conductors, cable rings, cable drums, conduits, ropes and cable drums). It enables trouble-free and rational working without tangled cables. The X BOARD XB500 has a diameter of Ø 500 mm and can be loaded up to 800 kg and is suitable for almost every type of drum, especially for damaged cable drums. 12 rubberised feet ensure a non-slip and stable base. The height-adjustable cover is perfectly designed to secure loose cables, cable rings or pipes in the X BOARD XB 500, thus preventing uncontrolled cable unwinding.

Possible applications



Possible applications in combination with the RUNPOSTICKS push rod set (XB 500 and XB 300)

Fix light drums

Helps tilting of large drums on to the X BOARD

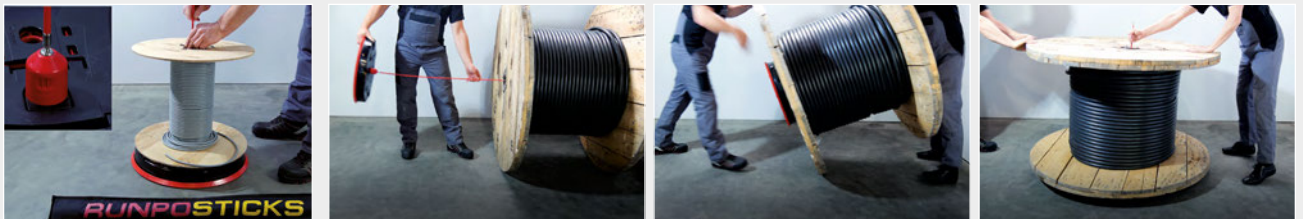

item		Item no.	Rec. trade price
	<p>X BOARD XB 500 Profi-cable roller, Ø 500 mm, load bearing capacity 800 kg, drum width variable incl. X BOARD mandrel and lateral clip system (for connection with RM35 cable length measuring device)</p>	10136	<p>265,00 € Promotional price 234,00 €</p>
	<p>X BOARD mandrel for X BOARD XB 300 and XB 500</p>	20632	10,00 €

PRO 530 | PRO 670 Cable drum roller



PRO 530
PRO 670

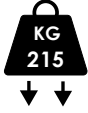

RM35 – digital cable length measuring device
● COMPATIBLE



- Completely pre-assembled
- Extra strong bearings and welded belt edges
- Adjustable support rollers
- Compact feet - stable, non-slip base
- Rubberized carrying handles
- Light and solid aluminium die casting and continuous casting

The cable drum unwinder made of light die-cast aluminum and continuous casting with robust, adjustable support rollers is ideal for the highest loads in daily use. The support rollers with spring core axles can be quickly adapted to different cable drum sizes up to a maximum of Ø 1000 mm by adjusting the spacing to 85, 160, 225, 290, 310 and 335 mm. The closed, maintenance-free drum bearings are equipped with welded belt edges and extra strong ball bearings. Four feet made of high-quality plastic ensure a stable and non-slip stand and protect finished floor coverings. PRO 530 and PRO 670 cable drum unwinders can be retrofitted with castors!

Different cable drum sizes up to max. Ø 1000 mm

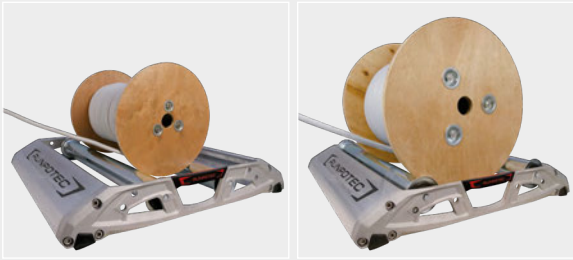





Castors can be retrofitted



Extra strong bearings and welded belt edges



Item		Item no.	Rec. trade price
	Cable drum roller pre-assembled, incl. support rollers load bearing capacity 215 kg		
	PRO 530 - max. drum width 530 mm PRO 670 - max. drum width 670 mm	10134 10135	189,00 € 219,40 €
	Castors in a 4-part set 4 pieces with parking brakes PU = 4 x castors	20623	73,00 €
	Support roller 530 for cable drum roller PRO 530 roller length 530 mm	20609	29,00 €
	Support roller 670 for cable drum roller PRO 670 roller length 670 mm	20610	31,00 €

All prices are ex-works 5303 - Thalgau - AUSTRIA - plus statutory taxes and duties. All price information represents non-binding price recommendations. Pricelist 2023. All illustrations are symbol photos. Typing and printing errors reserved.

AS 900 Roll-off rails



RM35 – digital cable length measuring device
● COMPATIBLE



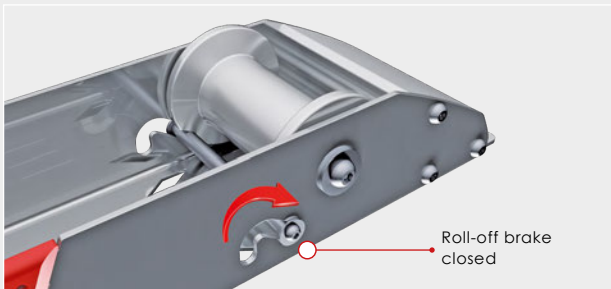
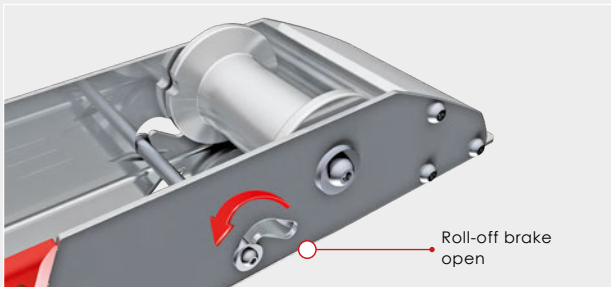

The **AS 900** unwinding rails are designed for safe unwinding of heavy cable material and cable drums from 450 mm to 2000 mm diameter. One of the two heavy duty rollers can be positioned in 3 different settings. The stable stainless steel-aluminium construction with high-quality, maintenance-free, ball bearing heavy-duty support rollers ensure a long service life. Easy and quick change of drums due to the unwinding brake. Due to their two-part narrow design they are easy to use in cramped spaces. Especially recommended where different cable types are to be processed side by side within a short time. Since some of the drums are in very poor condition, the recommended working load bearing capacity of 800 kg should not be exceeded.

Roll-off brake function



Possible application



Item	Item no.	Rec. trade price
  <p>AS 900 Roll-off rails set, 2 pieces Maximum load on the rollers: 1700 kg Recommended drum weight: 400 kg (depending on the condition of the wooden drum) Dimensions: L 935 mm W 345 mm H 165mm Weight: 23,03 kg stainless steel-aluminium construction</p>	10142	839,00 €

RUNPOLIFTER 4500 SET cable drum lifter



Foldable
Compact – easy transportation
Only 22 kg per lifting support







RM35 – digital cable length measuring device
COMPATIBLE

The **RUNPOLIFTER 4500** is a foldable cable drum lifter that is capable of lifting drums with a maximum diameter of 1600 mm and a maximum weight of 4500 kg and a max. width of 1250 mm. The two included centring cones each have a quick-fastener. Drums with a central hole up to Ø 115 mm can be fixed.

Scope of delivery:

- 1 x Lifting support right
- 1 x Lifting support left
- 1 x Drum shaft
- 2 x Centring cones



Item	Lifter Sets	Shaft length	Item no.	Rec. trade price
	Lifter 1150	1150 mm	10162	2610,00 €
	Lifter 1350	1350 mm	10163	2650,00 €
	Lifter 1600	1600 mm	10164	2690,00 €
	Drum shaft Ø 54 mm High strength hollow shaft, integrated heavy duty plain bearing, stainless steel security mount, high weight saving		20692	504,00 €
	Length 1150 mm – 11,00 kg - lifting capacity 4.500 kg		20693	546,00 €
	Length 1350 mm – 12,50 kg - lifting capacity 4.500 kg		20694	588,00 €
	Length 1600 mm – 14,30 kg - lifting capacity 4.500 kg Special lengths possible on request		20690	Price o. r.
	Centring cones (2 pieces) with quick-release fastener drum central hole up to Ø 115 mm		10147	135,00 €
	Lifter transport wheels 4 wheels including mounting screws (optionally retrofittable)		20711	135,00 €
	Lifting supports – RUNPOLIFTER 4500 left + right lifting support stainless steel, galvanised steel		10161	2090,00 €

All prices are ex-works 5303 - Thalgau - AUSTRIA - plus statutory taxes and duties. All price information represents non-binding price recommendations. Pricelist 2023. All illustrations are symbol photos. Typing and printing errors reserved.

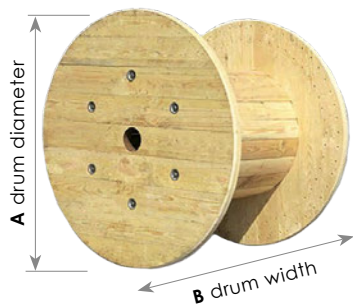

Application examples: Drum shaft lengths for suitable drum widths

Length **1600 mm** for drum width **up to 1250 mm**

Length **1350 mm** for drum width **up to 1000 mm**

Length **1150 mm** for drum width **up to 800 mm**

A drum diameter mm	610	710	810	910	1010	1210	1410	1610	1810
B drum width mm	490	520	520	690	710	890	890	1100	1100

cable diameter mm **Cable lengths in m on a drum**

	6	1113	2024	2755					
CAT5/6/7	7	845	1481	2340					
Coaxial	8	637	1064	1463	2731				
3 x 1,5 mm ²	9	472	892	1152	2202	2866			
3 x 2,5 mm ²	10	386	677	980	1768	2349			
5 x 2,5 mm ²	11	314	564	761	1404	1912			
1 x 25 mm ²	12	253	468	643	1206	1540			
	13	237	385	542	1032	1339	2727		
1 x 35 mm ²	14		364	454	881	1159	2265	2967	
7 x 2,5 mm ²	15		297	430	749	1000	1991	2479	
1 x 50 mm ²	16		239	358	632	860	1756	2205	
5 x 6 mm ²	17		226	294	603	736	1545	1959	
1 x 95 mm ²	18		218	281	505	705	1355	1737	
3 x 16 mm ²	19		172	228	485	599	1184	1535	2722
10 x 2,5mm ²	20		165	219	402	576	1139	1352	2435
5 x 10 mm ²	21		159	211	387	485	991	1304	2172
4 x 16 mm ²	22		122	167	315	468	856	1145	1931
	23		117	161	304	389	827	999	1869
5 x 16 mm ²	24		113	156	294	377	709	967	1657
1 x 185 mm ²	25		110	151	285	365	688	639	1608
3 x 35 mm ²	26		80	116	226	299	668	814	1419
3 x 50 mm ²	27		78	113	221	290	567	700	1244
1 x 240 mm ²	28		76	109	215	282	551	681	1211
24 x 2,5 mm ²	29		73	106	209	226	462	663	1180
5 x 35 mm ²	30		71	103	162	220	450	564	1028
4 x 50 mm ²	31			76	157	214	438	550	1003
1 x 300 mm ²	32			74	153	209	428	537	866
40 x 2,5 mm ²	33			72	150	204	352	451	846
	34				146	158	344	441	828
3 x 95 mm ²	35				108	154	336	431	707
5 x 50 mm ²	36				105	151	329	422	692
4 x 70 mm ²	37				103	148	265	348	678
3 x 120 mm ²	38					144	259	341	664
	39					107	254	334	560
4 x 95 mm ²	40					105	249	327	549
5 x 70 mm ²	41					102	244	264	539
3 x 150 mm ²	42					100	190	259	529
4 x 120 mm ²	43						187	254	437
	44						183	249	430
	45						180	245	422
5 x 95 mm ²	46						177	240	415
3 x 185 mm ²	47						174	187	408
	48						129	184	330
4 x 120 mm ²	49						127	181	325
5 x 120 mm ²	50						125	178	319
	51						123	175	314
3 x 240 mm ²	52						121	172	310
	53							170	305
4 x 185 mm ²	54							126	230
	55							124	235
	56							122	232
	57							121	228
	58							119	225
5 x 150 mm ²	59							117	222
3 x 240 mm ²	60								219
	61								216



The cable examples shown correspond to the load capacity of the RUNPOLIFTER (less than 4500 kg). Source: Leading cable dealers. All information are non-binding.

RC2 Inspection-camera

RC2 inspection-camera – compatible with all RUNPOTEC products with RTG Ø 6 mm thread

Monitor – 3.5" TFT LCD
16 M colors

RC2 inspection-camera in a robust stainless steel head with cable on a spool

Slot – Micro memory card, recording function

RUNPOTEC system case

W-BOX | Sortimo COMPATIBLE

RC2 inspection-camera with 6 integrated LED (camera probe protection rating IP67), enclosed in robust stainless steel head (Ø 13 mm) with RTG Ø 6 mm inside connecting thread – compatible to all RUNPOTEC products with RTG Ø 6 mm thread. ATTENTION: Compatible only with RUNPOTEC cable pulling systems! Preservation of evidence, storage function photo, video and audio documentation! Battery operation up to 6 hours. Areas of application: Pipe inspections over long distances of up to 50 m. Suitable for pipes with an inner diameter of 14 mm or more, but also for larger pipe cross-sections (ventilation systems, drainage systems, waste water pipes, etc.).

* Extensive accessories included

- A RG7 - guiding head with front thread
- B Systemglider RC2
- C High-performance 320-lumen rechargeable LED lamp (Rechargeable via USB-C charging socket)
- D USB / USB-C charging cable 1,5 m
- E USB EURO power plug 230 V
- F Micro memory card 8 GB / adapter
- G Magnet fishing-set
- H Fishing hook (Stainless steel)
- I RC2 thread attachment
- J Flexible attachment 12 cm
- K Connection thread set, RTG Ø 6 mm



Item		Length	Item no.	Rec. trade price
	RC 2 inspection-camera	10 m	10139	524,00 €
	with cable on reel and monitor	30 m	10140	566,00 €
	in the RUNPOTEC system case	50 m	10141	608,00 €
	* Included accessories, see above			

All prices are ex-works 5303 - Thalgau - AUSTRIA - plus statutory taxes and duties. All price information represents non-binding price recommendations. Pricelist 2023. All illustrations are symbol photos. Typing and printing errors reserved.

Application examples with RUNPOTEC cable pulling systems



Pipe inspection for large pipe diameters



Pipe inspection from Ø 14 mm and more



Protection rating IP67 waterproof



Ventilation inspection and servicing



Cavity wall inspection, locating and capturing



Shafts and underfloor ducting

30m



30m

SPECIAL OFFER

1 x GF3 Glass fiber Ø 3 mm – 30 m, incl. meter counter, description p. 25
1 x RC2 - inspektion-camera with 30 m cable

INSTEAD OF € 765,00

€ 659,-

plus VAT.

RC2 - 30 m - GF3 - 30 m – offer
RUNPOTEC item no. 11146



30m

SPECIAL OFFER

1 x RUNPOSTICKS comfort-package, description p. 22
1 x RC2 - inspektion-camera with 30 m cable

INSTEAD OF € 705,00

€ 643,-

plus VAT.

RUNPOSTICKS – RC2 - 30 m – offer
RUNPOTEC item no. 11137

50m



50m

SPECIAL OFFER













1 x GF4.5 Glass fiber Ø 4,5 mm – Profi-Set 50 m, incl. steel reel, description p. 34
1 x RC2 - inspektion-camera with 50 m cable

INSTEAD OF € 914,00





€ 789,-

plus VAT.

GF4.5 - 50 m – RC2 - 50 m – offer
RUNPOTEC item no. 11140

Item	Item no.	Rec. trade price
 <p>1 2</p>	<p>Camera probe RC 2 with cable 1 Ø 13 mm IP 67 RTG Ø6 mm incl. camera reel 10 m 20593 30 m 20560 50 m 20559 Camera reel RC 2 – empty 2 20608</p>	<p>208,00 € 291,00 € 335,00 € 29,00 €</p>
 <p>Detail: Micro-USB charging socket</p>	<p>High-performance rechargeable LED-lamp 320 lumen, incl. USB charging cable and battery, protection rating IP67 2 x RTG Ø 6 mm thread (1 x vertical and 1 x horizontal)</p>	<p>20485 46,00 €</p>
	<p>Systemglider RC2 L 130 mm W 58 mm H 53 mm RTG Ø 6 mm front thread</p>	<p>20606 21,50 €</p>
 <p>STAINLESS STEEL</p>	<p>RG7 - guiding head with front thread incl. swivel , stainless steel, RTG Ø 6 mm thread</p>	<p>20460 29,00 €</p>
	<p>Endoscope camera probe flexible 0,8 m Ø 9 mm for RC2 inspection-camera 300.000 Pixel (720 x 576), Fild of view 64°, protection rating IP 67, 4 x LED (dimnable)</p>	<p>20481 67,00 €</p>
 <p>Extra slim Ø 3,9 mm</p>	<p>Endoscope camera probe flexible 1 m Ø 3,9 mm for RC2 inspection-camera 100.000 Pixel (320 x 240), Fild of view 54°, IP 67 2 x LED (dimnable)</p>	<p>20488 137,00 €</p>
	<p>Thread attachment RC2 L 101 mm W 16 mm H 19 mm RTG Ø 6 mm front thread</p>	<p>20607 16,50 €</p>
	<p>Micro memory card 8 GB, class 6 incl. adapter and storage case</p>	<p>20483 6,60 €</p>
	<p>Magnet fishing-set 1,5 – 2,9 kg (pipe Ø 16 – 40 mm)</p>	<p>20475 23,00 €</p>
	<p>Connection thread set Set of 3 (1 x inside, 1 x outside, 1 x blindcap) RTG Ø 6 mm thread</p>	<p>20484 9,30 €</p>
 <p>1 2</p>	<p>Functionglider with RTG Ø 6 mm 1 Stainless steel fishing hook with RTG Ø 6 mm 2</p>	<p>20468 20,00 € 20261 6,80 €</p>
 <p>STAINLESS STEEL</p>	<p>Attachment flexible 12 cm stainless steel, RTG Ø 6 mm thread</p>	<p>20509 7,80 €</p>
	<p>RUNPOTEC system case with case insert for RC2 Inspektion-camera</p>	<p>20612 54,00 €</p>

All prices are ex-works 5303 - Thalgau - AUSTRIA - plus statutory taxes and duties. All price information represents non-binding price recommendations. Pricelist 2023. All illustrations are symbol photos. Typing and printing errors reserved.

Item	Item no.	Rec. trade price
 <div data-bbox="384 293 560 333" style="border: 1px solid red; padding: 2px; display: inline-block;">NON-INFLAMMABLE</div>	<p>Cable lubricant GEL 1000 g</p> <p>Not flammable Friction-reducing, improved gliding property, non-corrosive, heat-resistant up to 85°C/185°F, non-stick and non-staining, gentle on skin, biodegradable.</p>	<p>30064</p> <p>8,90 €</p>
 <div data-bbox="384 674 560 714" style="border: 1px solid red; padding: 2px; display: inline-block;">NON-INFLAMMABLE</div>	<p>Cable lubricant GEL 250 g</p> <p>Not flammable Friction-reducing, improved gliding property, non-corrosive, heat-resistant up to 85°C/185°F, non-stick and non-staining, gentle on skin, biodegradable.</p>	<p>30467</p> <p>4,40 €</p>
 <div data-bbox="384 1005 560 1046" style="border: 1px solid red; padding: 2px; display: inline-block;">NON-INFLAMMABLE</div>	<p>Cable lubricant SPRAY 400 ml</p> <p>Special attachment – spray large areas or open the tube for precise streams.</p> <p>Not flammable Excellent lubrication, non-stick, non-drying, colourless, odourless.</p>	<p>20523</p> <p>8,20 €</p>
 <div data-bbox="384 1386 560 1426" style="border: 1px solid red; padding: 2px; display: inline-block;">NON-INFLAMMABLE</div>	<p>Cable lubricant FOAM 400 ml</p> <p>Special attachment – spray large areas or open the tube for precise streams.</p> <p>Not flammable Excellent lubrication, water-soluble, non-stick, non-drying, VOC-free.</p>	<p>20522</p> <p>7,10 €</p>
	<p>Cable lubricant LIQUID 1000 ml</p> <p>Friction-reducing, non-stick and non-staining, colour- and odourless, water soluble</p>	<p>30063</p> <p>7,40 €</p>

RUNPO5 Profi cable pulling system – Ø 5,3 mm

VIDEO



RUNPO 5

KG 270

Triple twisted

PATENTED



Beginning: RG7 - guiding head
incl. swivel Ø 7 mm,
pressed onto strand

Ending: RG7 - guiding head
incl. swivel Ø 7 mm,
pressed onto strand

Attention!
electric
conductive

50 % less friction resistance

Only punctual contact

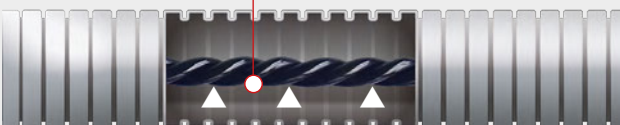

Advantages compared to fiberglass rod Ø 3 mm

- no buckling
- no sticking
- thereby time savings



Virtually break-free even with tightest radii





R

Total breaking load 270 Kg

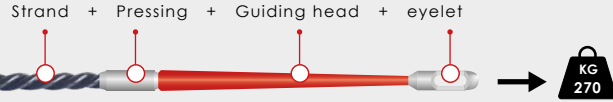

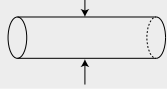
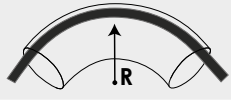

Strand + Pressing + Guiding head + eyelet



Rod	Rec. pipe diameter	bending radius	Total breaking load incl. RG7 - RUNPOGLIDER
Ø			
5,3 mm	16 – 40 mm	15 mm	270 kg

Item	Length	Item no.	Rec. trade price	
	RUNPO 5 Ø 5,3 mm – in plastic box incl. 2 x RG7 - guiding head incl. swivel triple twisted special plastic fish tape total breaking load 270 kg	20 m	10013	140,00 €
	30 m	10014	162,00 €	

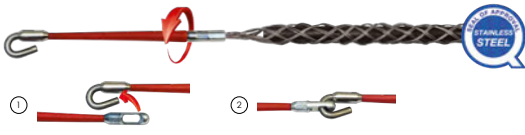
All prices are ex-works 5303 - Thalgau - AUSTRIA - plus statutory taxes and duties. All price information represents non-binding price recommendations. Pricelist 2023. All illustrations are symbol photos. Typing and printing errors reserved.

Item		Item no.	Rec. trade price
	RUNPO 5 replacement fish tape Ø 5,3 mm 2 x RG7 - guiding head incl. swivel triple twisted special plastic tape total breaking load 270 kg 20 m 30 m 40 m	20240 20241 20242	110,00 € 126,00 € 144,00 €
	RUNPOTEC system case with UNIVERSAL case insert	20613	54,00 €
	RUNPO 5 – empty box for replacement fish tape RUNPO 5 20 m or 30 meter	30146	35,00 €
	Cable pulling grip with quick-release fastener incl. swivel, stainless steel Ø 4 – 6 mm Ø 6 – 9 mm Ø 9 – 15 mm	20272 20273 20274	26,00 € 29,00 € 33,00 €
	Cable pulling loop with hook (quick-release fastener) – set of 4 Caps outside Ø: 14 17 23 30 mm stainless steel, PU = 4 pieces	10159	41,00 €

Information



Compatible cable pulling grip range see page 32.



30m

+



SPECIAL OFFER

1 x RUNPO 5, 30 m
1 x X BOARD XB300 with multifunction mandrel in RUNPOTEC system case, p. 8

INSTEAD OF € 383,⁴⁰

€ 305,⁰⁰
plus VAT.

RUNPO 5 - 30 m - XB300 - Multiset - offer
RUNPOTEC item no. 10171



30m

+



60m

Accessories included in the storage compartment



SPECIAL OFFER

1 x RUNPO5 - 30 m, description page 20
1 x GF4.5 fiberglass rod Ø 4,5 mm - 60 m, incl. steel cage

INSTEAD OF € 493,⁰⁰

€ 399,⁰⁰
plus VAT.











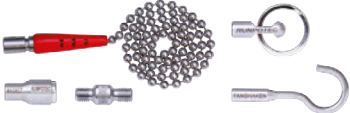



















RUNPO 5 - 30 m - GF4.5 - 60 m - offer
RUNPOTEC item no. 11120

RUNPOSTICKS



Item		Item no.	Rec. trade price
	<p>RUNPOSTICKS comfort-package (19-parts)</p> <p>10 x basalt rods with extreme bending radius, 5 x 1 m red/hard Ø 7,5 mm, 3 x 1 m black/medium Ø 5,5 mm, 2 x 1 m yellow/soft Ø 4,5 mm stainless steel, RTG Ø 6 mm thread</p> <p>1 x RG7 - guiding head incl. swivel, 1 x strong magnet, 1 x connection thread, 1 x ball chain, 1 x eyelet with ring, 1 x fishing hook, 1 x special sliding hook, stainless steel 1 x shockproof LED-lamp incl. 1 x AAA battery 1 x storage bag with shoulder strap</p>	10020	139,00 €
	<p>RUNPOSTICKS standard-package (17-parts)</p> <p>Content: same as RUNPOSTICKS comfort-package without special sliding hook and shockproof LED-lamp (Description see above)</p>	10016	119,00 €
	<p>Special sliding hook – Stainless steel overcomes obstacles up to 8 cm, excellent gliding behaviour for all surfaces, with tilt function, extensive mounting options for cable RTG Ø 6 mm thread</p>	30239	20,20 €
	<p>Functionglider RTG Ø 6 mm thread</p>	20468	20,00 €
	<p>LED-Lamp 130 lumen incl. 1 x AAA battery, shockproof, extra long battery life, RTG Ø 6 mm thread</p>	20059	21,00 €
	<p>High-performance rechargeable LED-lamp 320 lumen, Protection rating: IP67, Micro-USB-charging socket (for battery in housing) 2 x RTG Ø 6 mm thread (1 x vertical and 1 x horizontal)</p>	20485	46,00 €

All prices are ex-works 5303 - Thalgau - AUSTRIA - plus statutory taxes and duties. All price information represents non-binding price recommendations. Pricelist 2023. All illustrations are symbol photos. Typing and printing errors reserved.

Item	Item no.	Rec. trade price
 	10042	24,00 €
  <p>Video RG - RUNPOGLIDER guiding head</p>	20238	29,00 €
 	10043	19,00 €
 	10044	20,00 €
 	10045	20,00 €
 	20457	12,00 €
 	20261	6,80 €
 	30236	5,30 €
 	20260	9,00 €
 	30210	4,20 €
 	20262	10,00 €
 	20428 20427	6,90 € 6,90 €
  <p>Product fish hook set</p>	20614	24,00 €
	20455	17,00 €
	30009	22,00 €
  <p>Video cable pulling loop</p>	10154	41,00 €

RP1 Cable pulling rod Ø 4 mm



RG - RUNPOGLIDER



Beginning: RG6 - guiding head with special eyelet Ø 6 mm, pressed onto strand.



Ending: Eyelet Ø 6 mm, RTG Ø 6 mm thread, screwed to strand

RP1 is not suitable for RT 2008!





RP 1, special plastic fish tape Ø 4 mm. Special eyelet: 1 x RG6 - guiding head with special eyelet. Excellent bending and gliding behavior, large eyelet with hole up to 7 x 2.5 mm² cable, perfect fabrication, no hems and high breaking load. Ending: with screwable eyelet with RTG Ø 6 mm thread. Optimal pipe diameters: Tube Ø 16, 25 and 32 mm

Rod	Rec. pipe diameter	Bending radius rod	TBL - ending	Total breaking load - beginning
Ø 4 mm	16 - 32 mm	15 mm	170 mm	170 kg

Item	Length	Item no.	Rec. trade price
 <p>RP 1 – special plastic fish tape with RG6 - RUNPOGLIDER guiding head Ø 4 mm Total breaking load: 170 Kg</p>	5 m	30027	16,60 €
	10 m	30028	17,90 €
	15 m	30029	21,50 €
	20 m	30030	25,00 €
	25 m	30042	29,60 €
	30 m	30043	34,30 €

ACCESSORIES – useful in combination with RP1

Item	Ø	Item no.	Rec. trade price
 <p>Cable pulling grip with quick-release fastener incl. swivel stainless steel</p>	4 – 6 mm 6 – 9 mm 9 – 15 mm	20272 20273 20274	26,00 € 29,00 € 33,00 €
 <p>Application: Quick-release fastener compatible with RG - RUNPOGLIDER guiding head</p>			
 <p>Eyelet-set Ø 7 mm, stainless steel RTG Ø 6 mm thread, PU = 3 pieces</p>	7 mm	20487	9,10 €

All prices are ex-works 5303 - Thalgau - AUSTRIA - plus statutory taxes and duties. All price information represents non-binding price recommendations. Pricelist 2023. All illustrations are symbol photos. Typing and printing errors reserved.

GF3 Glass Fiber Ø 3 mm – Cable pulling system

VIDEO



GF3

KG
130

PATENTED

RC2 - Inspection-camera COMPATIBLE



Ergonomic holding and carrying handle

RG7 - Guiding head with front thread incl. swivel and kink protection

Automatic glide back protection

Integrated digital meter counter – m/ft



Accessory box (16-parts)

Attention!
electrically conductive



Front end: Guiding head with RTG Ø 6 mm front thread, swivel and kink protection



Rear end: Kink protection with RTG Ø 6 mm inner thread

*Accessory box (16-parts)



Extreme bending radius

Revolutionary kink protection

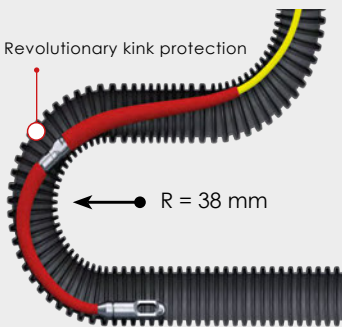

R = 38 mm





Easy service opening / accessory box





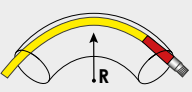









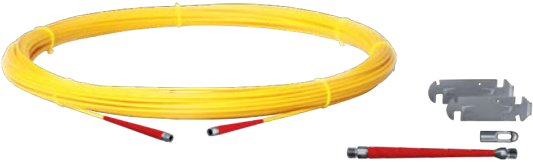









Anti-slip coating

Just open one screw









Accessory box 16-parts

Rod	Rec. pipe diameter	Bending radius w. e. joint	Bending radius rod	Breaking load	Total breaking load
Ø					
3 mm	10 – 50 mm	38 mm	28 mm	450 kg	130 kg

Item		Length	Item no.	Rec. trade price
	<p>GF3 Glass Fiber Ø 3 mm with integrated digital meter counter – ft/m 2 x kink protection on fiberglass rod 16-piece accessories (*see content) Box with anti-slip coating</p>	20 m	10192	184,00 €
		30 m	10193	199,00 €
		50 m	10195	Introduitory price 169,00 € 219,00 €
	<p>GF3 Glass Fiber Ø 3 mm without meter counter 2 x kink protection on fiberglass rod 16-piece accessories (*see content) Box with anti-slip coating</p>	20 m	10196	117,50 €
		30 m	10197	131,00 €
		50 m	10198	156,50 €

Item	Item no.	Rec. trade price
	<p>Replacement fiberglass rod GF3 Ø 3 mm incl. RG7 - Guiding head with front thread and eyelet Ø 7 mm incl. swivel RTG Ø 6 mm thread 20 m 30 m 50 m</p>	<p>20816 46,50 € 20817 54,60 € 20818 66,00 €</p>
 	<p>Repairing-kit GF3 Ø 3 mm – 15-parts 1 x RG7 - Guiding head with front thread 2 x Kink protection 1 x Special glue 3 g 2 x Mounting wrench 1 x Eyelet Ø 7 mm 6 x Adhesive joint for Ø 3 mm 1 x Coupling joint for Ø 3 mm 1 x Starting head Ø 11 mm stainless steel, RTG Ø 6 mm thread</p>	<p>20819 36,80€</p>
 	<p>Guiding head with kink protection-set GF3 Ø 3 mm Ø 3 mm 1 x RG7 - Guiding head with front thread 1 x Kink protection 2 x Mounting wrench 1 x Eyelet Ø 7 mm stainless steel, RTG Ø 6 mm thread</p>	<p>20826 30,50 €</p>
	<p>Adhesive joint-set GF3 Ø 3 mm Brass, PU = 6 pieces</p>	<p>20824 6,00 €</p>
 	<p>Mounting-wrench Set GF3 Ø 3 mm stainless steel PU = 2 pieces</p>	<p>20825 4,20 €</p>
 	<p>Eyelet-set Ø 7 mm stainless steel, RTG Ø 6 mm thread, PU = 3 pieces</p>	<p>20487 9,10 €</p>
 	<p>Eyelet-set Ø 7 mm stainless steel, RTG Ø 6 mm thread, PU = 3 pieces</p>	<p>20411 7,00 €</p>
 	<p>Pull loop, stainless steel rope Ø 1,5 mm (loop length 85 mm) RTG Ø 6 mm thread</p>	<p>20428 6,90 €</p>
 	<p>Pull loop 2 mm, stainless steel rope Ø 2 mm (loop length 50 mm) RTG Ø 6 mm thread</p>	<p>20427 6,90 €</p>
 	<p>Starting head Ø 11 mm stainless steel, RTG Ø 6 mm thread</p>	<p>20829 4,00 €</p>
	<p>Magnet fishing-set 1,5 – 2,9 kg (tube Ø 16 – 40 mm) 5 kg STRONG (tube Ø 50 – 100 mm) RTG Ø 6 mm thread</p>	<p>20475 23,00 € 20476 46,00 €</p>
 	<p>Coupling joint-set GF3 Ø 3 mm stainless steel PU = 3 pieces</p>	<p>20108 7,00 €</p>

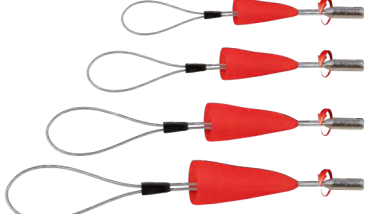
All prices are ex-works 5303 - Thalgau - AUSTRIA - plus statutory taxes and duties. All price information represents non-binding price recommendations. Pricelist 2023. All illustrations are symbol photos. Typing and printing errors reserved.

Item	Item no.	Rec. trade price
	<p>Pulling grip for fiberglass rod Ø 3 – 6 mm</p>	<p>30070 6,20 €</p>
	<p>Special glue 3 g</p>	<p>30050 8,20 €</p>
  <p>Quick connection compatible with RG - guiding head</p>	<p>Cable pulling grip with quick-release fastener incl. swivel stainless steel</p> <p>Ø 4 – 6 mm Ø 6 – 9 mm Ø 9 – 15 mm</p>	<p>20272 26,00 € 20273 29,00 € 20274 33,00 €</p>
	<p>Cable pulling grip with thread incl. swivel stainless steel, RTG Ø 6 mm thread</p> <p>Ø 4 – 6 mm Ø 6 – 9 mm Ø 9 – 13 mm</p>	<p>20365 18,00 € 20366 19,00 € 20367 29,00 €</p>
	<p>Cable pulling grip with loop and thread incl. swivel stainless steel, RTG Ø 6 mm thread</p> <p>Ø 9 – 15 mm Ø 15 – 19 mm Ø 19 – 25 mm Ø 25 – 31 mm</p>	<p>20266 40,00 € 20267 42,00 € 20268 43,00 € 20269 45,00 €</p>
	<p>Cable pulling loop with RTG 6 thread – set of 4 Protective caps outside Ø: 14 17 23 30 mm stainless steel, RTG Ø 6 mm thread PU = 4 pieces</p>	<p>10154 41,00 €</p>
 <p>NON-INFLAMMABLE</p>	<p>Cable lubricant SPRAY 400 ml Cable lubricant FOAM SPRAY 400 ml (with folding spray tube) Non inflammable</p> <p>Cable lubricant GEL 1000 g Cable lubricant GEL 250 g</p>	<p>20523 8,20 € 20522 7,10 €</p> <p>30064 8,90 € 30467 4,40 €</p>

RT 2008 Mechanical cable pulling tool



The problem solver for low pipe cross section Ø 16 – 32 mm



Attention!
electric
conductive



W-BOX® | Sortimo COMPATIBLE

1. Induct



2. Fix



3. Pump



Item		Item no.	Rec. trade price
	RUNPOTEC RT 2008 - complete set 1 x RT 2008 1 x RUNPOTEC system case, with RT 2008 case inlay 1 x MET4 metal spiral with RG6 - guiding head – 15 m Plug-in attachments: 1 x Ø 20 mm, 1 x Ø 25 mm, 1 x Ø 32 mm, 1 x Ø 40 mm, 1 x socket flexible, 2 x plug in coupling, 1 x belt clip	10000	299,00 €
	RUNPOTEC RT 2008 incl. clamping element	20004	178,00 €
	Set plug in coupling + belt clip	20333	8,00 €
	Plug-in attachment Ø 20 mm	20020	9,00 €
	Plug-in attachment Ø 25 mm	20025	9,00 €
	Plug-in attachment Ø 32 mm	20032	9,00 €
	Plug-in attachment Ø 40 mm	20040	9,00 €
	Plug-in attachment socket flexible	20010	8,00 €
	Plug-in attachment 90° rigid socket (also for pipe Ø 16 and 20 mm)	20253	17,00 €
	RUNPOTEC system case with RT 2008 case inlay	20611	54,00 €

All prices are ex-works 5303 - Thalgau - AUSTRIA - plus statutory taxes and duties. All price information represents non-binding price recommendations. Pricelist 2023. All illustrations are symbol photos. Typing and printing errors reserved.

MET4 Steel fish tape Ø 4 mm



Beginning: RG7 - guiding head with special eyelet Ø 6 mm, pressed onto strand.

Ending: Eyelet Ø 6 mm, pressed onto strand



Optimal in combination with the revolutionary RT 2008

 3 times offset wound metal spiral

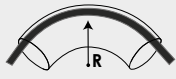

Application example / symbol image

MET4, metal spiral Ø 4 mm. Special eyelet: 1 x RG6 - guiding head with special eyelet. Excellent bending and gliding behavior, large eyelet with hole up to 7 x 2.5 mm² cable, perfect fabrication, no hems and high breaking load. Ending: eyelet Ø 6 mm, pressed onto strand. Optimal pipe diameters: Tube Ø 16, 25 and 32 mm

Rod	Rec. pipe diameter	Bending radius rod	TBL - ending	Total breaking load - beginning
Ø				
4 mm	16 - 32 mm	25 mm	170 Kg	170 Kg

Item	Length	Item no.	Rec. trade price	
	MET4 metal spiral	5 m	30054	19,00 €
	Ø 4 mm	10 m	30017	26,00 €
	Total breaking load:	15 m	30018	34,00 €
	170 Kg	20 m	30019	42,00 €
		25 m	30020	50,00 €
		30 m	30021	54,00 €
	Lengths up to 50 m possible		30031	Price o. r.

ACCESSORIES – useful in combination with MET4

Item	Ø	Item no.	Rec. trade price	
	Cable pulling grip with quick-release fastener incl. swivel, stainless steel	4 – 6 mm	20272	26,00 €
		6 – 9 mm	20273	29,00 €
		9 – 15 mm	20274	33,00 €
Application: Quick-release fastener compatible with RG - RUNPOGLIDER guiding head				

CABLE PULLING LOOP with hook (quick connection) / RTG 6 thread



Cable pulling loop with hook or RTG Ø 6 mm thread, with protective cap and flexible loop made of stainless steel with Ø 1.5 mm. Optimal field of application: To pull pre-fabricated cables incl. plugs in a protected manner. For pipes with an inner diameter of 14 mm or more and non-guided lines.

Examples: pulling force transferred to the cable

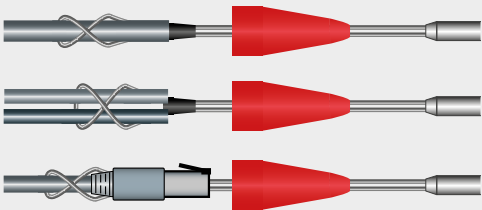

Use the protective cap to pull the plugs through pipes or other situations in a protected manner. 4 variants for different plug sizes.

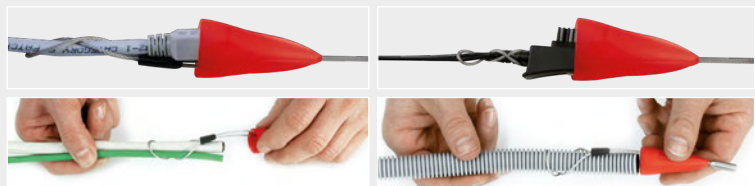

Connect: cable pulling loop with hook (compatible with all RUNPOTEC products with RG - guide heads)



Connect: pulling loop with RTG Ø 6 mm thread

Swivel allows the cable to rotate in the tube



Item		Caps inner Ø	Caps outside Ø	Item no.	Rec. trade price
	Cable pulling loop with hook (quick-release fastener) – set of 4 Total breaking load: 100 kg stainless steel PU = 4 pieces	12 mm 15 mm 20 mm 27 mm	14 mm 17 mm 23 mm 30 mm	10159	41,00 €
	Cable pulling loop with hook (quick-release fastener) – individually Total breaking load: 100 kg stainless steel	12 mm 15 mm 20 mm 27 mm	14 mm 17 mm 23 mm 30 mm	20628 20629 20630 20631	14,00 € 14,50 € 15,00 € 15,50 €
	Cable pulling loop with RTG 6 thread – set of 4 Total breaking load: 100 kg stainless steel, RTG Ø 6 mm thread PU = 4 pieces	12 mm 15 mm 20 mm 27 mm	14 mm 17 mm 23 mm 30 mm	10154	41,00 €
	Cable pulling loop with RTG 6 thread – individually Total breaking load: 100 kg stainless steel, RTG Ø 6 mm thread	12 mm 15 mm 20 mm 27 mm	14 mm 17 mm 23 mm 30 mm	20624 20625 20626 20627	14,00 € 14,50 € 15,00 € 15,50 €

All prices are ex-works 5303 - Thalgau - AUSTRIA - plus statutory taxes and duties. All price information represents non-binding price recommendations. Pricelist 2023. All illustrations are symbol photos. Typing and printing errors reserved.

CABLE PULLING GRIP with hook (quick connection) / RTG 6 thread / loop



For **cable diameter Ø 4 – 15 mm**. Compatible with RUNPO5, RP1, GF3 / GF4.5 / GF6 fiberglass rod, RUNPOSTICKS. Made of high quality stainless steel weave. Extremely long service life thanks to new connection technology.

Item	Total breaking load	Weave length	Ø	Item no.	Rec. trade price
Cable pulling grip with quick-release fastener incl. swivel, stainless steel	 200 kg	280 mm	Ø 4 – 6 mm	20272	26,00 €
		310 mm	Ø 6 – 9 mm	20273	29,00 €
		460 mm	Ø 9 – 15 mm	20274	33,00 €



For **cable diameter Ø 4 – 13 mm**. Compatible with GF3 / GF4.5 / GF6 fiberglass rod and RUNPOSTICKS. Made of high quality stainless steel weave. High-quality materials with a long service life!
 Advantages of swivel: Cable can rotate in the tube, prevents unintentional unscrewing from the thread.

Item	Total breaking load	Weave length	Ø	Item no.	Rec. trade price
Cable pulling grip with RTG Ø 6 mm thread incl. swivel stainless steel	 120 kg	200 mm	Ø 4 – 6 mm	20365	18,00 €
		220 mm	Ø 6 – 9 mm	20366	19,00 €
		320 mm	Ø 9 – 13 mm	20367	29,00 €



For **cable diameter Ø 4 – 13 mm**. Compatible with GF3 / GF4.5 / GF6 fiberglass rod and RUNPOSTICKS. Made of high quality stainless steel weave. High-quality materials with a long service life!
 Advantages of swivel: Cable can rotate in the tube, prevents unintentional unscrewing from the thread.

Item	Total breaking load	Weave length	Ø	Item no.	Rec. trade price
Cable pulling grip with loop incl. swivel loop length 100 mm, stainless steel	 200 kg	270 mm	Ø 4 – 6 mm	30039	21,00 €
		290 mm	Ø 6 – 9 mm	30040	23,00 €
		390 mm	Ø 9 – 13 mm	30041	35,00 €



For **cable diameter Ø 9 – 31 mm**. Compatible with GF3 / GF4.5 / GF6 / GF7.5 / GF9 / GF11 fiberglass rod and RUNPOSTICKS. Made of high quality stainless steel weave. High-quality materials with a long service life!
 Advantages of swivel: Cable can rotate in the tube, prevents unintentional unscrewing from the thread.

Item	Total breaking load	Weave length	Ø	Item no.	Rec. trade price
Cable pulling grip with loop and RTG Ø 6 mm thread incl. swivel stainless steel Information: Not optimal in combination with CW800E capstan winch	180 kg	430 mm	Ø 9 – 15 mm	20266	40,00 €
		480 mm	Ø 15 – 19 mm	20267	42,00 €
		480 mm	Ø 19 – 25 mm	20268	43,00 €
		530 mm	Ø 25 – 31 mm	20269	45,00 €
Quick-release fastener with RTG Ø 6 mm thread For connecting RUNPOTEC cable pulling grip with RTG Ø 6 mm thread to all RUNPOTEC products with the RG - RUNPOGLIDER guiding head				20388	22,00 €



For **cable diameter Ø 30 – 100 mm**. Preferably in combination with all fiberglass rods and RUNPOTEC products with RTG Ø 12 mm thread. Made of high quality stainless steel weave.
 Advantages of swivel: Cable can rotate in the tube, prevents unintentional unscrewing from the thread.

Item	Total breaking load	Weave length	Ø	Item no.	Rec. trade price
Cable pulling grip with loop and RTG Ø 12 mm thread incl. swivel With additional RTG Ø 6 mm thread stainless steel Information: Not optimal in combination with CW800E capstan winch	1200 kg	920 mm	Ø 30 – 40 mm	20436	62,00 €
		1020 mm	Ø 40 – 50 mm	20437	66,00 €
		1120 mm	Ø 50 – 60 mm	20438	70,00 €
		1220 mm	Ø 60 – 70 mm	20439	79,00 €
		1320 mm	Ø 70 – 85 mm	20440	93,00 €
		1420 mm	Ø 85 – 100 mm	20441	110,00 €



For **cable diameter Ø 10 – 100 mm**. Preferably combined with CW 800 E capstan winch. Made of flexible, galvanized steel double weave. In the case of permanent tension, it is recommended to work in combination with the connection swirl with swivel (see accessories item no. 10176).

Item	Total breaking load	Weave length	Ø	Item no.	Rec. trade price
Cable pulling grip with loop Flexible, galvanized steel double weave Long lifetime 	1019 kg	600 mm	Ø 10 - 15 mm	20661	40,00 €
	2080 kg	600 mm	Ø 15 - 20 mm	20662	42,00 €
	2080 kg	600 mm	Ø 20 - 25 mm	20663	43,00 €
	2080 kg	1000 mm	Ø 25 - 30 mm	20664	47,00 €
	3059 kg	1250 mm	Ø 30 – 40 mm	20665	53,00 €
	4078 kg	1250 mm	Ø 40 – 50 mm	20666	58,00 €
	4996 kg	1500 mm	Ø 50 – 60 mm	20667	68,00 €
	4996 kg	1500 mm	Ø 60 – 70 mm	20668	80,00 €
	4996 kg	1500 mm	Ø 70 – 85 mm	20669	93,00 €
	5812 kg	1500 mm	Ø 85 – 100 mm	20670	106,00 €

ACCESSORIES – Optimal in combination with cable pulling grip, pull rope and CW 800 E capstan winch

Item	Item no.	Rec. trade price
Connection swirl with swivel Ø 30 mm L 144 mm, stainless steel	10176	190,00 €

All prices are ex-works 5303 - Thalgau - AUSTRIA - plus statutory taxes and duties. All price information represents non-binding price recommendations. Pricelist 2023. All illustrations are symbol photos. Typing and printing errors reserved.

Cabel examples with diameters

Cabel pulling grip

Cable-symbolphoto	Cable Ø	Cable section	Cable identification	Ø	Item no.
	5 mm	2 x 0,5 mm ²	Loudspeaker	4-6 mm	20272
	5,4 mm	-	Phone	4-6 mm	20365
				4-6 mm	30039
	7 mm	-	CAT5/6/7	6-9 mm	20273
	7 mm	1 x 6 mm ²	NYM-J	6-9 mm	20366
	8 mm	-	Coaxial	6-9 mm	30040
	9 mm	3 x 1,5 mm ²	NYM-O		
	10 mm	3 x 2,5 mm ²	NYM	9-13 mm	20367
	10 mm	1 x 10 mm ²	NYY-O	9-13 mm	30041
	10 mm	1 x 16 mm ²	NYM-O	9-15 mm	20274
	11 mm	7 x 1,5 mm ²	NYM-O	9-15 mm	20266
	11 mm	5 x 2,5 mm ²	NYM	10 - 15 mm	20661
	11 mm	5 x 1,5 mm ²	NYY		
	13 mm	3 x 2,5 mm ²	NYY		
	14 mm	1 x 35 mm ²	NYY-O		
	15 mm	12 x 1,5 mm ²	NYM-JZ		
	15 mm	7 x 2,5 mm ²	NYM		
	15 mm	3 x 6 mm ²	NYM-J		
	15 mm	-	CAT6 duplex		
	17 mm	16 x 1,5 mm ²	NYM-J	15-19 mm	20267
	17 mm	5 x 6 mm ²	NYM-J	15 - 20 mm	20662
	18 mm	4 x 10 mm ²	NYM-J		
	18 mm	1 x 95 mm ²	NYY-O		
	20 mm	10 x 2,5 mm ²	NYCY	19-25 mm	20268
	21 mm	5 x 10 mm ²	NYY-J	20 - 25 mm	20663
	22 mm	12 x 2,5 mm ²	NYCY		
	22 mm	4 x 16 mm ²	NYM-J		
	24 mm	7 x 6 mm ²	NYCY		
	25 mm	1 x 185 mm ²	NYY-O		
	28 mm	3 x 35 mm ²	NYCWY	25-31 mm	20269
	29 mm	24 x 2,5 mm ²	NYCY	25 - 30 mm	20664
	32 mm	1 x 300 mm ²	NYY-O	30-40 mm	20436
	33 mm	40 x 2,5 mm ²	NYY-JZ		20665
	34 mm	5 x 35 mm ²	NYM-J		
	40 mm	3 x 95 mm ²	NYCWY		
	45 mm	3 x 120 mm ²	NYCWY	40-50 mm	20437
	47 mm	3 x 150 mm ²	NYCWY		20666
	52 mm	5 x 95 mm ²	NYY-J	50-60 mm	20438
	54 mm	3 x 185 mm ²	NYCWY		20667
	60 mm	3 x 240 mm ²	NYCWY		
	63 mm	4 x 240 mm ²	NYY-J	60-70 mm	20439
					20668

GF4.5 Fiberglass rod Ø 4.5 mm – Cable pulling system



GF4.5

KG 220

PATENTED

RC2 – Inspection-camera COMPATIBLE



Profi-Set

Ergonomic holding and carrying handle

Lateral parking brake

RG7 - Guiding head with front thread and eyelet

Double run-out system, quick outlet and automatic run-out brake

Extendable standing feet and storage compartment incl. accessories



Beginning: RG7 - Guiding head with swivel Ø 7 mm, RTG Ø 6 mm thread, screwed to strand



Ending: Ending joint, stainless steel, RTG Ø 6 mm thread

Attention! electric conductive

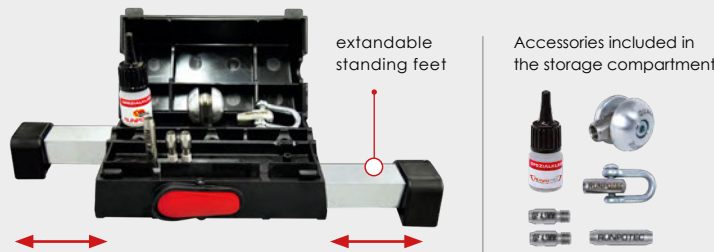

Included in the Profi-Set:
Extendable standing feet a. storage compartment incl. accessories



Included in the Profi-Set and Standard-Set:
Lateral parking brake and double run-out system (quick outlet and automatic run-out brake)



Rod	Rec. pipe diameter	Bending radius w. e. joint	Bending radius rod	Breaking load	Total breaking load
Ø 4,5 mm	30 – 80 mm	120 mm	55 mm	1300 kg	220 kg

Item		Length	Item no.	Rec. trade price
 <p>GF4.5 Fiberglass rod Ø 4.5 mm – Profi-Set</p> <ul style="list-style-type: none"> • extendable standing feet • storage compartment on both sides incl. extensive accessories • double run-out system and lateral parking brake • RG7 - Guiding head with front thread and eyelet incl. swivel • Robust CDP / powder-coated steel reel 		30 m	10052	252,00 €
		40 m	10055	279,00 €
		50 m	10057	306,00 €
		60 m	10047	331,00 €
		80 m	10050	384,00 €
 <p>GF4.5 Fiberglass rod Ø 4.5 mm – Standard-Set</p> <ul style="list-style-type: none"> • double run-out system and lateral parking brake • RG7 - Guiding head with front thread and eyelet incl. swivel • Robust CDP / powder-coated steel reel 		30 m	10054	186,00 €
		40 m	10056	212,00 €
		50 m	10058	237,00 €
		60 m	10048	261,00 €
		80 m	10051	315,00 €

All prices are ex-works 5303 - Thalgau - AUSTRIA - plus statutory taxes and duties. All price information represents non-binding price recommendations. Pricelist 2023. All illustrations are symbol photos. Typing and printing errors reserved.

Special offer / accessories / spare parts

30m

60m

Accessories included in the storage compartment

SPECIAL OFFER

1 x RUNPO 5 - 30 m, description page 20

1 x GF4.5 fiberglass rod Ø 4,5 mm - 60 m incl. steel cage

INSTEAD OF € 493,00

€ 399,-
plus VAT.

RUNPO 5 - 30 m - GF4.5 - 60 m - offer
RUNPOTEC item no. 11120

50m

50m

SPECIAL OFFER

1 x GF4.5 fiberglass rod Ø 4,5 mm - 50 m, description page 34























1 x RC2 Inspection-camera - 50 m, in the system case

INSTEAD OF € 914,00

€ 789,-
plus VAT.

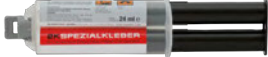
RC2 - 50 m - GF4.5 - 50 m - offer
RUNPOTEC item no. 11140

Item		Ø mm	Length	Item no.	Rec. trade price
	GF4.5 Replacement fiberglass rod Ø 4,5 mm with ending joints on both sides RTG Ø 6 mm thread		30 m	20311	80,00 €
			40 m	20312	94,00 €
			50 m	20313	110,00 €
			60 m	20314	127,00 €
			80 m	20315	157,00 €
<p>Video RG - RUNPOGLIDER guiding head</p>	RG7 - Guiding head with front thread and eyelet Ø 7 mm incl. swivel stainless steel, RTG Ø 6 mm thread			20460	29,00 €
<p>Symbol picture</p>	Flexible starting head stainless steel RTG Ø 6 mm thread	7 10 13		20116 20303 20119	7,80 € 8,00 € 8,00 €
<p>Information: Cable pulling grip range see page 32</p>	Cable pulling grip with swivel stainless steel RTG Ø 6 mm thread		9 - 15 15 - 19 19 - 25 25 - 31	20266 20267 20268 20269	40,00 € 42,00 € 43,00 € 45,00 €
<p>NON-INFLAMMABLE</p>	Cable lubricant SPRAY 400 ml Cable lubricant FOAM SPRAY 400 ml (with folding spray tube) Non inflammable Cable lubricant GEL 1000 g Cable lubricant GEL 250 g			20523 20522	8,20 € 7,10 €
				30064	8,90 €
				30467	4,40 €

Item	Item no.	Rec. trade price
	<p>Roller Ø 25 mm stainless steel / aluminium RTG Ø 6 mm thread</p>	<p>20279 18,00 €</p>
	<p>Shackle stainless steel / galvanised steel RTG Ø 6 mm thread</p>	<p>20280 15,00 €</p>
  <p>Repair manual www.runpotec.com</p> 	<p>Repairing kit GF4 for Ø 4,5 mm 1 x special glue 3 g, 1 x coupling joint, 2 x ending joint RTG Ø 6 mm</p>	<p>20250 22,00 €</p>
 	<p>Ending joint set GF4 for Ø 4,5 mm stainless steel, RTG Ø 6 mm thread PU = 3 ending joint</p>	<p>20322 11,00 €</p>
 	<p>Coupling joint set GF4 for Ø 4,5 mm stainless steel PU = 3 coupling joint</p>	<p>20323 14,00 €</p>
 	<p>Eyelet Ø 8 mm stainless steel, RTG Ø 6 mm thread</p>	<p>30208 4,80 €</p>
 	<p>Eyelet-set Ø 7 mm stainless steel, RTG Ø 6 mm thread</p>	<p>20487 9,10 €</p>
 	<p>Swivel joint Ø 11 mm stainless steel, RTG Ø 6 mm thread</p>	<p>20251 24,00 €</p>
 	<p>Pull loop, stainless steel rope RTG Ø 6 mm thread Ø 1,5 mm (loop length 85 mm) Ø 2 mm (loop length 50 mm)</p>	<p>20428 6,90 € 20427 6,90 €</p>
	<p>Special glue 3 g</p>	<p>30050 8,20 €</p>
	<p>2 components special glue 24 ml</p>	<p>30067 20,00 €</p>
	<p>Pulling grip for fiberglass rod Ø 3 – 12 mm</p>	<p>30070 6,20 €</p>
	<p>Extendable standing feet incl. storage compartment for reel Ø 330 mm and Ø 530 mm</p>	<p>20278 42,00 €</p>
	<p>Profi-set steel reel Ø 330 mm for Ø 4,5 mm incl. double run-out system with extendable standing feet and storage compartment for accessories CDP/powder coated</p>	<p>20402 178,00 €</p>
	<p>Standard-Set steel reel Ø 330 mm for Ø 4,5 mm incl. double run-out system and parking brake CDP/powder coated</p>	<p>20002 129,00 €</p>

All prices are ex-works 5303 - Thalgau - AUSTRIA - plus statutory taxes and duties. All price information represents non-binding price recommendations. Pricelist 2023. All illustrations are symbol photos. Typing and printing errors reserved.

GF6 Fiberglass rod Ø 6 mm – cable pulling system



VIDEO

GF6



KG
320



PATENTED



RC2 –
Inspection-camera
COMPATIBLE



Profi-Set

Ergonomic holding and carrying handle

Lateral parking brake

RG7 - Guiding head with front thread and eyelet

Double run-out system, quick outlet and automatic run-out brake

Extendable standing feet and storage compartment incl. accessories



Beginning: RG7 - Guiding head with swivel Ø 7 mm, RTG Ø 6 mm thread, screwed to strand



Ending: Ending joint, stainless steel, RTG Ø 6 mm thread



Attention! electric conductive

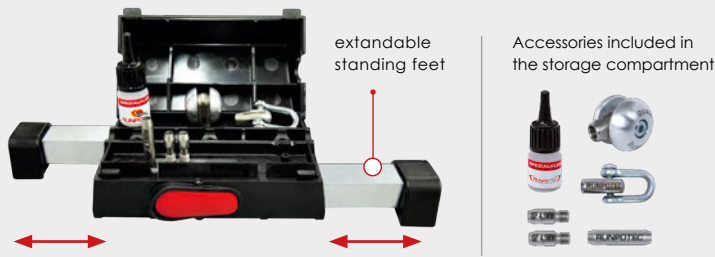

Included in the Profi-Set:
Extendable standing feet a. storage compartment incl. accessories



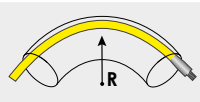
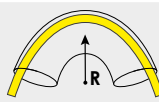
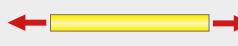























Included in the Profi-Set and Standard-Set:
Lateral parking brake and double run-out system (quick outlet and automatic run-out brake)















Rod	Rec. pipe diameter	Bending radius w. e. joint	Bending radius rod	Breaking load	Total breaking load
Ø					
6 mm	40 – 100 mm	168 mm	80 mm	2200 kg	320 kg

Item		Length	Item no.	Rec. trade price
	GF6 Fiberglass rod Ø 6 mm – Profi-Set	40 m	10059	312,00 €
	• extendable standing feet	50 m	10061	339,00 €
	• storage compartment on both sides incl. extensive accessories	60 m	10063	370,00 €
	• double run-out system and lateral parking brake	80 m	10065	435,00 €
	GF6 Fiberglass rod Ø 6 mm – Standard-Set	40 m	10060	257,00 €
	• double run-out system and lateral parking brake	50 m	10062	284,00 €
	• RG7 - Guiding head with front thread and eyelet incl. swivel	60 m	10064	315,00 €
	• Robust CDP / powder-coated steel reel	80 m	10066	379,00 €

Item	Item no.	Rec. trade price
	<p>GF6 Replacement fiberglass rod Ø 6 mm with ending joints on both sides RTG Ø 6 mm thread</p> <p>40 m 50 m 60 m 80 m</p>	<p>20317 103,00 € 20318 125,00 € 20319 144,00 € 20320 182,00 €</p>
 <p>Video RG - RUNPOGLIDER guiding head</p> 	<p>RG7 - Guiding head with front thread and eyelet Ø 7 mm incl. swivel stainless steel, RTG Ø 6 mm thread</p>	<p>20460 29,00 €</p>
 	<p>Flexible starting head Ø 7 mm stainless steel, RTG Ø 6 mm thread</p>	<p>20116 7,80 €</p>
 	<p>Flexible starting head Ø 10 mm stainless steel, RTG Ø 6 mm thread</p>	<p>20303 8,00 €</p>
 	<p>Flexible starting head Ø 13 mm stainless steel, RTG Ø 6 mm thread</p>	<p>20119 8,00 €</p>
 <p>Information: Cable pulling grip range see page 32</p> 	<p>Cable pulling grip with swivel stainless steel, RTG Ø 6 mm thread</p> <p>Ø 9 – 15 mm Ø 15 – 19 mm Ø 19 – 25 mm Ø 25 – 31 mm</p>	<p>20266 40,00 € 20267 42,00 € 20268 43,00 € 20269 45,00 €</p>
	<p>Roller Ø 25 mm stainless steel / aluminium RTG Ø 6 mm thread</p>	<p>20279 18,00 €</p>
	<p>Shackle stainless steel / galvanised steel RTG Ø 6 mm thread</p>	<p>20280 15,00 €</p>
 <p>Repair manual, www.runpotec.com</p> 	<p>Repairing kit GF6 for Ø 6 mm 1 x 2K-special glue 24 ml 2 x ending joints, RTG Ø 6 mm thread 1 x coupling joint</p>	<p>20252 39,00 €</p>
 	<p>Ending joint-set GF6 for Ø 6 mm stainless steel, RTG Ø 6 mm thread PU = 2 ending joint</p>	<p>20316 12,00 €</p>
 	<p>Coupling joint-set GF6 for Ø 6 mm stainless steel PU = 2 coupling joint</p>	<p>20321 14,00 €</p>
 	<p>Pulling eyelet Ø 8 mm stainless steel, RTG Ø 6 mm thread</p>	<p>30208 4,80 €</p>
 	<p>Pulling eyelet-set Ø 7 mm stainless steel, RTG Ø 6 mm thread</p>	<p>20487 9,10 €</p>
 	<p>Swivel joint Ø 11 mm stainless steel, RTG Ø 6 mm thread</p>	<p>20251 24,00 €</p>

All prices are ex-works 5303 - Thalgau - AUSTRIA - plus statutory taxes and duties. All price information represents non-binding price recommendations. Pricelist 2023. All illustrations are symbol photos. Typing and printing errors reserved.

Item		Item no.	Rec. trade price
	 Pull loop , stainless steel rope Ø 1,5 mm (loop length 85 mm) RTG Ø 6 mm thread	20428	6,90 €
	 Pull loop 2 mm , stainless steel rope Ø 2 mm (loop length 50 mm) RTG Ø 6 mm thread	20427	6,90 €
	Special glue 3 g	30050	8,20 €
	2 components special glue 24 ml	30067	20,00 €
	Pulling grip for fiberglass rod Ø 3 – 12 mm	30070	6,20 €
	Extendable standing feet incl. storage compartment for reel Ø 330 mm and Ø 530 mm PU = 1 piece	20278	42,00 €
	Profi-set steel reel Ø 530 mm for Ø 6 mm incl. double run-out system with extendable standing feet and storage compartment for accessories CDP/powder coated	20403	224,00 €
	Standard-Set steel reel Ø 530 mm for Ø 6 mm incl. double run-out system and parking brake CDP/powder coated	20300	166,00 €
	 Cable lubricant SPRAY 400 ml Cable lubricant FOAM SPRAY 400 ml (with folding spray tube) Non inflammable Cable lubricant GEL 1000 g Cable lubricant GEL 250 g	20523 20522	8,20 € 7,10 €
		30064 30467	8,90 € 4,40 €

Information

The fiberglass rods Ø 4,5 mm, Ø 6 mm, the RUNPOSTICKS basalt rods and the entire accessories are compatible!

FLEXIBLE LEADING HEAD-SET



Flexible leading head-set: can be adapted on roller, shackle and starting head Ø 20 mm and Ø 30 mm.



Connectivity options:

The sticks can each be extended by 1 m and adapted as flexible leading head-set on fiberglass rods Ø 7,5 mm / 9 mm and 11 mm to get around narrow bends. It is additionally possible to screw on accessories such as the roller or guiding head with swivel at the tip.

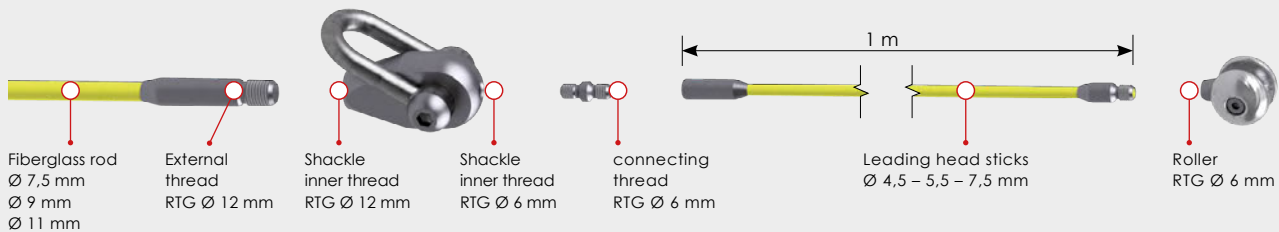



Application example: flexible leading head-set

The problem situation:
Fiberglass rod Ø 7,5 mm, Ø 9 mm or 11 mm stops at to narrow radii from of the tube.

Solution:
With leading head-set, taper off through the flexible sticks Ø 4,5 mm (yellow), Ø 5,5 mm (black) oder Ø 7,5 mm (red). Thereby it makes it possible to get over the last bend or radii.

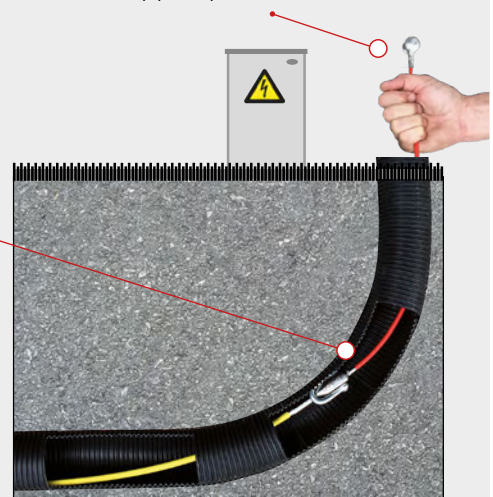
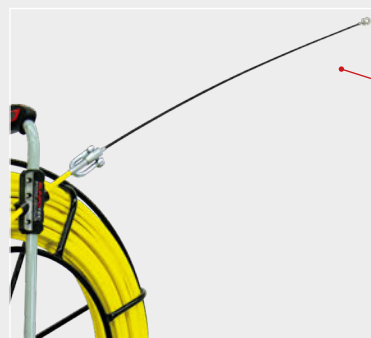
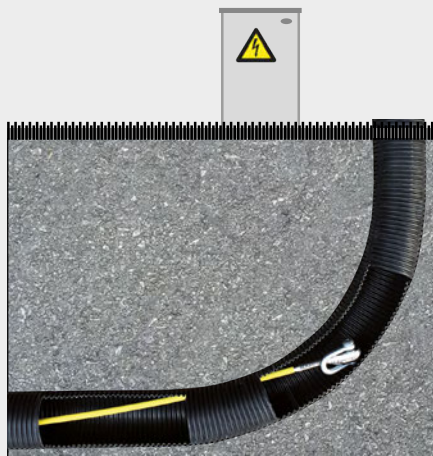
Tooltip:
Additional manual haul support possible.



Item	Item. no.	Rec. trade price
 <p>Flexible leading head-set – 13 parts Included accessories of flexible leading head-set with RTG Ø 6 mm thread: 2 x sticks Ø 4,5 mm, 2 x sticks Ø 5,5 mm, 2 x sticks Ø 7,5 mm, 1 x RG7 - guiding head with front thread, roller Ø 24 mm, 3 x coupling thread, 1 x blindcap, 1 x starting head Ø 20 mm</p>	20442	99,00 €

All prices are ex-works 5303 - Thalgau - AUSTRIA - plus statutory taxes and duties. All price information represents non-binding price recommendations. Pricelist 2023. All illustrations are symbol photos. Typing and printing errors reserved.

GF7.5 / GF9 Fiberglass rod Ø 7,5 / 9 mm – Cable pulling system

VIDEO



GF7.5/GF9

KG 400
Ø 7,5 mm

KG 460
Ø 9 mm

RC2 – Inspection-camera COMPATIBLE



- Ergonomic holding and carrying handle
- Autom. run-out brake
- Lateral parking brake
- Meter counter with hardened thumb wheel
- Quick run with mounted rollers
- Mobile reel
- CDP / powder-coated
- 2 x threaded bolts (for roller or starting head)



Rod tip: Shakel, stainless steel, RTG Ø 12 mm thread, screwed to strang



Rod end: Ending joint, stainless steel, RTG Ø 12 mm thread

Double run-out-system
(Quick run and automatic run-out brake)

Quick run with mounted rollers

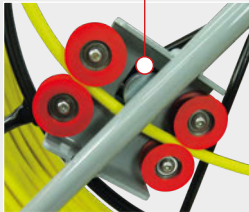

Automatic run-out brake



Meter counter with hardened thumb wheel





6-digit roller counter with meter and 10 cm steps



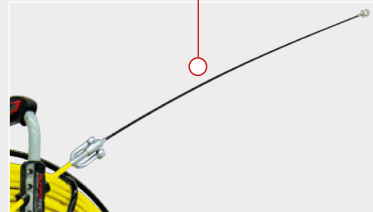

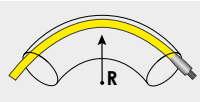

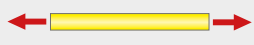









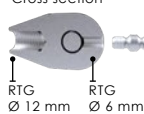

Additional option:
Adaptable leading heads

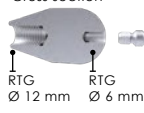
13-parts leading head-Set see page 40

















Rod	Rec. pipe diameter	Bending radius w. e. joint	Bending radius rod	Breaking load	Total breaking load
Ø					
7,5 mm	50 – 120 mm	500 mm	115 mm	3400 kg	400 kg
9 mm	60 – 200 mm	620 mm	140 mm	4500 kg	460 kg

Item		Length	Item. no.	Rec. trade price	
	GF7.5 Fiberglass rod Ø 7,5 mm , mobile, Ø 730 mm				
		• Meter counter with hardened thumb wheel	40 m	10076	442,00 €
		• Double-run-out-system with parking brake	50 m	10077	463,00 €
		• Rod tip with shackle	60 m	10078	482,00 €
		• Robust CDP / powder-coated steel reel	80 m	10079	523,00 €
			100 m	10080	559,00 €
	120 m	10091	592,00 €		
	GF9 Fiberglass rod Ø 9 mm , mobile, Ø 730 mm				
		• Meter counter with hardened thumb wheel	40 m	10081	445,00 €
		• Double-run-out-system with parking brake	50 m	10082	475,00 €
		• Rod tip with shackle	60 m	10083	504,00 €
		• Robust CDP / powder-coated steel reel	80 m	10084	559,00 €
			100 m	10085	606,00 €
			120 m	10086	637,00 €
			150 m	10110	725,00 €

Item	Item no.	Rec. trade price
	<p>GF7.5 Replacement fiberglass rod Ø 7.5 mm, ending joints on both sides RTG Ø 12 mm thread</p> <p>40 m 50 m 60 m 80 m 100 m 120 m</p>	<p>20368 126,00 € 20369 142,00 € 20370 161,00 € 20371 201,00 € 20372 237,00 € 20414 273,00 €</p>
	<p>GF9 Replacement fiberglass rod Ø 9 mm, ending joints on both sides RTG Ø 12 mm thread</p> <p>40 m 50 m 60 m 80 m 100 m 120 m 150 m</p>	<p>20373 140,00 € 20374 166,00 € 20375 193,00 € 20376 240,00 € 20377 300,00 € 20378 340,00 € 20562 404,00 €</p>
 <p>Cross section  RTG Ø 12 mm RTG Ø 6 mm incl. connection thread (for flexible leading head or small-sized cable pulling grip)</p>	<p>Roller Ø 50 mm stainless steel / aluminium RTG Ø 12 mm thread incl. connection thread</p>	<p>20382 39,00 €</p>
 <p>Cross section  RTG Ø 12 mm RTG Ø 6 mm incl. connection thread (for flexible leading head or small-sized cable pulling grip)</p>	<p>Shackle stainless steel, galvanised steel RTG Ø 12 mm thread incl. connection thread</p>	<p>20383 27,00 €</p>
 <p>Cross section  RTG Ø 12 mm RTG Ø 6 mm incl. connection thread (for flexible leading head or small-sized cable pulling grip)</p>	<p>Starting head Ø 30 mm stainless steel, RTG Ø 12 mm thread incl. connection thread</p>	<p>20404 25,00 €</p>
 <p>Cross section  RTG Ø 12 mm RTG Ø 6 mm incl. connection thread (for flexible leading head or small-sized cable pulling grip)</p>	<p>Starting head Ø 20 mm stainless steel, RTG Ø 12 mm thread incl. connection thread</p>	<p>20409 23,00 €</p>
 	<p>Swivel joint stainless steel, RTG Ø 12 mm thread</p>	<p>20387 35,00 €</p>
	<p>Meter counter for steel reel Ø 730 mm incl. mounting set</p>	<p>20461 106,00 €</p>
	<p>Run-out rollers set (set of 4) for reel Ø 730 mm and Ø 1000 mm incl. fixing set</p>	<p>20646 31,00 €</p>
 <p>Repair manual, www.runpotec.com</p> 	<p>Repairing kit GF7.5 and GF9 1 x 2K-special glue 24 ml 2 x ending joints, RTG Ø 12 mm 1 x coupling joint for Ø 7,5 mm for Ø 9 mm</p>	<p>20384 46,00 € 20385 51,00 €</p>

All prices are ex-works 5303 - Thalgau - AUSTRIA - plus statutory taxes and duties. All price information represents non-binding price recommendations. Pricelist 2023. All illustrations are symbol photos. Typing and printing errors reserved.

Item	Item no.	Rec. trade price
  <p>Ending joint stainless steel, RTG Ø 12 mm thread for Ø 7,5 mm for Ø 9 mm</p>	<p>20381 20379</p>	<p>10,00 € 10,00 €</p>
  <p>Coupling joint stainless steel for Ø 7,5 mm for Ø 9 mm</p>	<p>20380 20412</p>	<p>14,00 € 14,00 €</p>
  <p>Blind cap set stainless steel, RTG Ø 6 mm thread PU = 3 blind cap set</p>	<p>20443</p>	<p>5,80 €</p>
 <p>2 components special glue 24 ml</p>	<p>30067</p>	<p>20,00 €</p>
 <p>Steel reel Ø 730 mm, mobile for Ø 7,5 mm and 9 mm incl. double run-out system and meter counter CDP/powder coated</p>	<p>20405</p>	<p>320,00 €</p>
  <p>Cable pulling grip with swivel stainless steel, RTG Ø 12 mm thread Ø 9 – 15 mm Ø 15 – 19 mm Ø 19 – 25 mm Ø 25 – 31 mm</p> <p>Information: Cable pulling grip range see page 32</p>	<p>20266 20267 20268 20269</p>	<p>40,00 € 42,00 € 43,00 € 45,00 €</p>
 <p>Flexible leading head-set - 13 parts, Basalt rods - plastic coated, stowed in storage bag</p> <p>Information: Flexible leading head-set see page 40</p>	<p>20442</p>	<p>99,00 €</p>
  <p>Cable lubricant SPRAY 400 ml Cable lubricant FOAM SPRAY 400 ml (with folding spray tube) Non inflammable</p> <p>Cable lubricant GEL 1000 g Cable lubricant GEL 250 g</p>	<p>20523 20522 30064 30467</p>	<p>8,20 € 7,10 € 8,90 € 4,40 €</p>
 <p>Cable lubricant LIQUID 1000 ml</p>	<p>30063</p>	<p>7,40 €</p>

RUNPOTEC camera compatible

The RUNPOTEC camera – is also compatible with fiberglass rod Ø 7,5 mm, Ø 9 mm, Ø 11 mm and Ø 15 mm. This allows the coupling thread RTG Ø 12 mm to RTG Ø 6 mm thread. See page 16

GF11 Fiberglass rod Ø 11 mm – Cable pulling system



- Ergonomic holding and carrying handel
- Autom. Run-out brake
- Lateral parking brake
- Meter counter with hardened thumb wheel
- Quick run with mounted rollers
- Mobile reel CDP/ powder-coated
- 2 x threaded bolts (for roller or starting head)



Rod tip: Shakel, stainless steel, RTG Ø 12 mm thread, screwed to strang



Rod end: Ending joint, stainless steel, RTG Ø 12 mm thread

Double run-out-system (Quick run and automatic run-out brake)

Quick run with mounted rollers

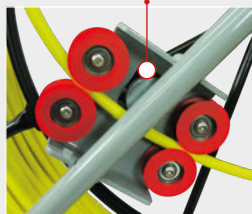

Automatic run-out brake



Meter counter with hardened thumb wheel

6-digit roller counter with meter and 10 cm steps



Additional option: Adaptable leading heads



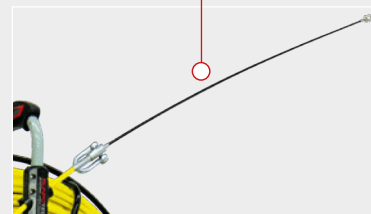









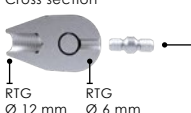

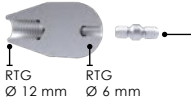

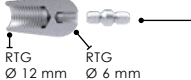





13-parts leading head-Set see page 40

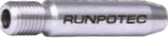

Rod	Rec. pipe diameter	Bending radius w. e. joint	Bending radius rod	Breaking load	Total breaking load
Ø					
11 mm	80 – 250 mm	770 mm	210 mm	6200 kg	580 kg

Item		Length	Item no.	Rec. trade price
	GF11 Fiberglass rod Ø 11 mm, mobile, Ø 1000 mm	100 m	10092	736,00 €
	• Meter counter with hardened thumb wheel	120 m	10093	807,00 €
	• Double-run-out-system with parking brake	150 m	10094	909,00 €
	• Rod tip with shackle	200 m	10095	1085,00 €
	• Robust CDP / powder-coated steel reel	250 m	10096	1268,00 €
		300 m	10097	1369,00 €
	GF11 Replacement fiberglass rod Ø 11 mm	100 m	20386	508,00 €
	ending joints on both sides	120 m	20417	519,00 €
	RTG Ø 12 mm thread	150 m	20418	646,00 €
		200 m	20419	808,00 €
		250 m	20420	954,00 €
		300 m	20421	1111,00 €

All prices are ex-works 5303 - Thalgau - AUSTRIA - plus statutory taxes and duties. All price information represents non-binding price recommendations. Pricelist 2023. All illustrations are symbol photos. Typing and printing errors reserved.

Item	Item no.	Rec. trade price
 <p>Cross section</p>  <p>incl. connection thread (for flexible leading head or small-sized cable pulling grip)</p> <p>RTG Ø 12 mm RTG Ø 6 mm</p>	20382	39,00 €
 <p>Cross section</p>  <p>incl. connection thread (for flexible leading head or small-sized cable pulling grip)</p> <p>RTG Ø 12 mm RTG Ø 6 mm</p>	20383	27,00 €
 <p>Cross section</p>  <p>incl. connection thread (for flexible leading head or small-sized cable pulling grip)</p> <p>RTG Ø 12 mm RTG Ø 6 mm</p>	20404	25,00 €
 <p>Cross section</p>  <p>incl. connection thread (for flexible leading head or small-sized cable pulling grip)</p> <p>RTG Ø 12 mm RTG Ø 6 mm</p>	20409	23,00 €
 	20387	35,00 €
	20462	112,00 €
	20646	31,00 €
    <p>Repair manual, www.runpotec.com</p>	20424	59,00 €
 	20422	12,00 €
 	20423	17,00 €
 	20443	5,80 €
	30067	20,00 €
	20416	399,00 €

Information



Compatible cable pulling grip range see page 32.



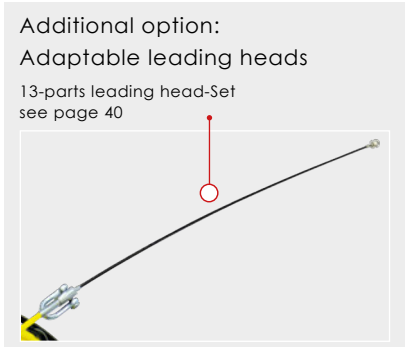
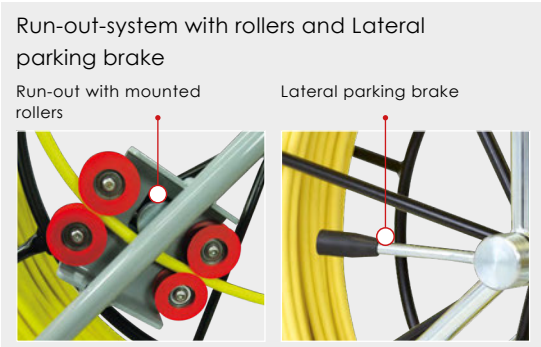
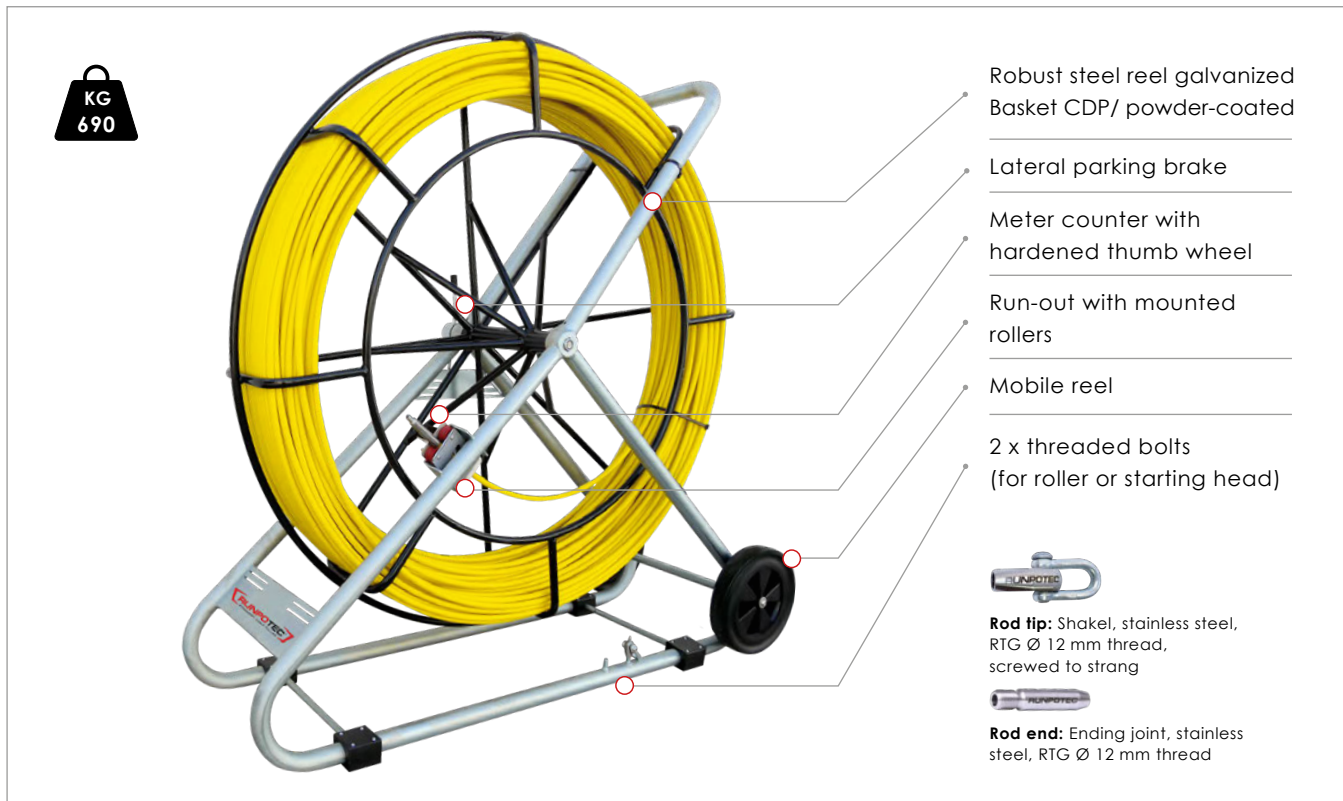









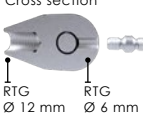





GF15 Fiberglass rod Ø 15 mm – Cable pulling system



Rod	Rec. pipe diameter	Bending radius w. e. joint	Bending radius rod	Breaking load	Total breaking load
Ø					
15 mm	180 – 450 mm	1200 mm	800 mm	14500 kg	690 kg

Item		Length	Item no.	Rec. trade price
	GF15 Fiberglass rod Ø 15 mm, mobile, Ø 1400 mm	150 m	10099	2473,00 €
	• Meter counter with hardened thumb wheel	200 m	10100	2726,00 €
	• Run-out-system with rollers and lateral parking brake	250 m	10101	3003,00 €
	• Rod tip with shackle	300 m	10102	3256,00 €
	• Robust steel reel - galvanized	350 m	10103	3533,00 €
	• Reel basket - CDP / powder-coated	400 m	10104	3818,00 €
	GF15 Replacement fiberglass rod Ø 15 mm	150 m	20491	999,00 €
	with ending joints on both sides	200 m	20492	1235,00 €
	RTG Ø 12 mm thread	250 m	20493	1500,00 €
		300 m	20494	1762,00 €
		350 m	20495	2020,00 €
		400 m	20496	2324,00 €

All prices are ex-works 5303 - Thalgau - AUSTRIA - plus statutory taxes and duties. All price information represents non-binding price recommendations. Pricelist 2023. All illustrations are symbol photos. Typing and printing errors reserved.

Item	Item no.	Rec. trade price
 <p>Cross section</p>  <p>incl. Connection thread (for flexible leading head or small-sized cable pulling grip)</p> <p>RTG Ø 12 mm RTG Ø 6 mm</p>	20382	39,00 €
 <p>Cross section</p>  <p>incl. Connection thread (for flexible leading head or small-sized cable pulling grip)</p> <p>RTG Ø 12 mm RTG Ø 6 mm</p>	20383	27,00 €
 <p>Cross section</p>  <p>incl. Connection thread (for flexible leading head or small-sized cable pulling grip)</p> <p>RTG Ø 12 mm RTG Ø 6 mm</p>	20404	25,00 €
 <p>Cross section</p>  <p>incl. Connection thread (for flexible leading head or small-sized cable pulling grip)</p> <p>RTG Ø 12 mm RTG Ø 6 mm</p>	20409	23,00 €
 	20387	35,00 €
  <p>Repair manual, www.runpotec.com</p>	20489	172,00 €
 	20490	55,00 €
 	20498	56,00 €
	30067	20,00 €
	20497	1591,00 €
 <p>Information: Flexible leading head-set see page 40</p>	20442	99,00 €

Information



Compatible cable pulling grip range see page 32.

CW 800 E capstan winch for horizontal cable pulling



CW 800 E

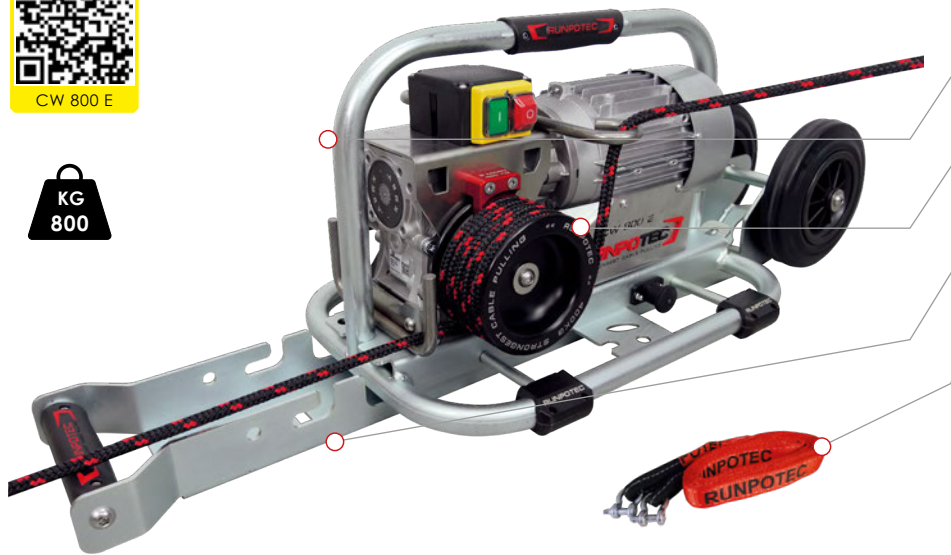

EXTRA STRONG, provides the pulling power of 8 – 10 people

Rope pulley (capstan) small
Ø 55 mm, 4 m/min., max. 800 kg

Rope pulley (capstan) large
Ø 110 mm, 8 m/min., max. 400 kg

Trolley mounting rail with 2 wheels and many mounting options

Belt (3 m) with loops including 2 fastening shackles

SPECIAL OFFER

CW800E with 3 free cable pulling grip. See back of catalogue.

The CW 800 E capstan winch is ideal for pulling one or more cables horizontally. One person is enough to move at either 4 m/min | max. 800 kg or 8 m/min | max. 400 kg to pull the cables. The CW 800 E can be attached to objects using the mounting holes, with the strap, or on the trolley mounting rail using the two fixing bolts. The trolley mounting rail itself can be attached to the trailer hitch of cars through the special coupling opening, and mounted horizontally or vertically.

Safety notice: Not suitable for vertical cable pulling, must not be used to carry or lift loads or persons.

Item		Item no.	Rec. trade price
	<p>CW 800 E Capstan winch for horizontal cable pulling incl. steel trolley mounting rail and 3 m strap Total weight: 41,5 kg Motor connection: 230 V 50 Hz Motor power: 0,75 KWh 5,1 A</p>	10138	2299,00 €
	<p>CW 800 E Capstan winch for horizontal cable pulling Total weight: 32 kg Motor connection: 230 V 50 Hz Motor power: 0,75 KWh 5,1 A</p>	10148	2204,00 €
	<p>Trolley mounting rail for capstan winch CW 800 E Easy to transport due to wheels and ergonomic handle, versatile mounting options steel galvanised</p>	20622	139,00 €
	<p>Capstan head Spare part for CW 800 E capstan winch Diameter Ø 55 mm – Tension load 800 kg Diameter Ø 110 mm – Tension load 400 kg</p>	20658 20657	157,00 € 190,00 €

All prices are ex-works 5303 - Thalgau - AUSTRIA - plus statutory taxes and duties. All price information represents non-binding price recommendations. Pricelist 2023. All illustrations are symbol photos. Typing and printing errors reserved.

The portable CW 800 E capstan winch can be fastened in various ways:

The housing can be screwed to the floor **1**, or with a strap and suitable accessories through the attachment eye **2** fixed to a solid object (e.g., tree). You can also fix the housing on the trolley **3** by means of locking bolts **4** on the rail. The trolley itself can be screwed down, hung directly on a trailer hitch **5** or fixed with a strap through the attachment eye to a fixed object.

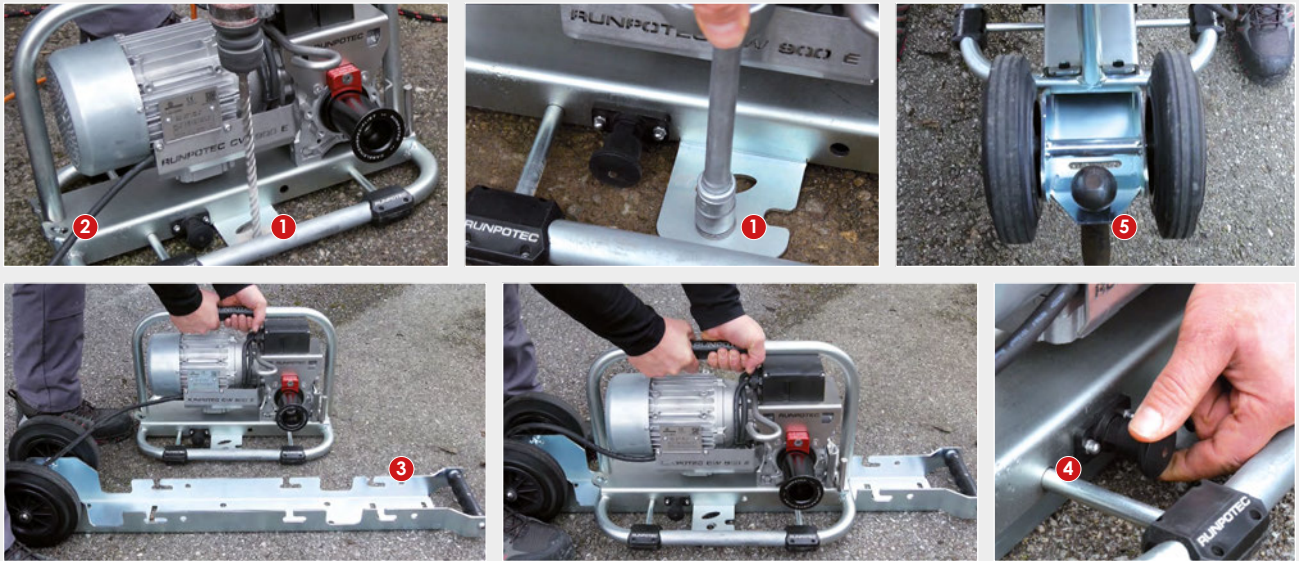

Application of the CW 800 E capstan winch:

The cable to be pulled is connected, preferably with a connection swirl with swivel, with the pull rope.



The towing rope is guided past inside the rope guide pin **6**. Wrap the towing rope at least 3 times around the capstan winch (**7** or **8**) and then lead out through the rope guide **9**. Keep the towing rope tight, so that it does not get tangled up.

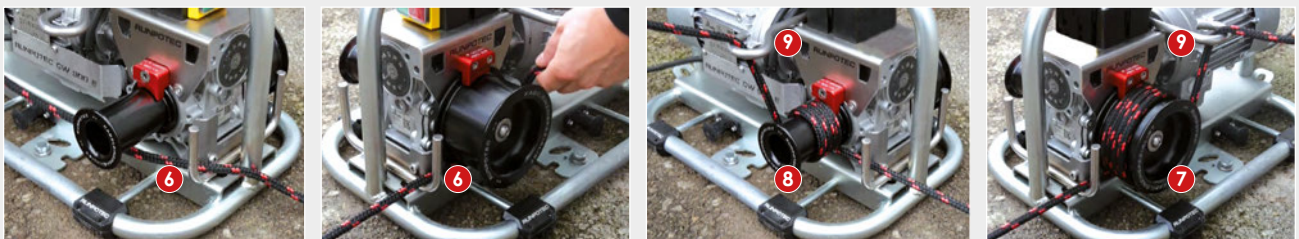

The operator stands next to the capstan winch with a sufficient safety distance and pulls with little effort at a 90° angle to the pulling direction on the pull rope. The effort should only be so strong until the feed rate is reached. Very strong pulling does not increase the pulling power of the capstan winch!



POLYESTER CABLE PULLING ROPE incl. steel reel



KG
1100

Steel reel 514/70



KG
1640

Steel reel 770/98



KG
2180

Steel reel 770/192

The **polyester pulling rope** Ø 10 mm and Ø 12 mm is suitable for horizontal cable pull with the CW 800 E capstan winch. For the horizontal cable pull, the use of the connection swivel with twist compensation is recommended, it reduces the frictional resistance and thus protects the cable and pull-in system. The steel reel enables controlled winding and unwinding of the rope.



Safety notice: Not suitable for the vertical cable pull, must not be used to bear/lift loads or people.

*Pulling rope Ø 8 mm is not suitable for pulling the cable with the CW 800 E capstan winch.

Item	Rope Ø	Total breaking load	Length	Reel basket Ø	Internal reel basket	Item no.	Rec. trade price
 <p>Pulling rope incl. steel reel and parking brake CDP / powder coated Spliced loops at the start and end of the rope</p>	* 8 mm	1100 kg	120 m	514 mm	70 mm	10169	369,00 €
	10 mm	1640 kg	120 m	514 mm	70 mm	10167	415,00 €
			200 m	770 mm	98 mm	10168	565,00 €
	12 mm	2180 kg	150 m	770 mm	98 mm	10120	588,00 €
			200 m	770 mm	98 mm	10121	657,00 €
			300 m	770 mm	192 mm	10122	797,00 €
350 m			770 mm	192 mm	10123	889,00 €	

Item	Rope Ø	Total breaking load	Length	Reel basket Ø	Drum height	Item no.	Rec. trade price
 <p>Pulling rope on drum Spliced loops at the start and end of the rope</p>	* 8 mm	1100 kg	120 m	230 mm	217 mm	20621	127,00 €
	10 mm	1640 kg	120 m	250 mm	300 mm	20619	173,00 €
			200 m	300 mm	300 mm	20620	254,00 €
	12 mm	2180 kg	150 m	300 mm	345 mm	20615	264,00 €
			200 m	350 mm	330 mm	20616	346,00 €
			300 m	400 mm	380 mm	20617	495,00 €
350 m			400 mm	430 mm	20618	578,00 €	

Item	Reel basket Ø	Internal reel basket	Item no.	Rec. trade price
 <p>Rope reel 514 Rope reel 770 small Rope reel 770 wide</p>	514 mm	70 mm	20527	251,00 €
	770 mm	98 mm	20526	325,00 €
	770 mm	192 mm	20525	330,00 €

Item	Weave length	Total breaking load	Ø	Item no.	Rec. trade price
 <p>Cable pulling grip with loop</p> <p>Weave length</p> <p>Application example</p>  <p>Optimal combination: Pulling rope – connection swirl with swivel – cable pulling grip</p>	600 mm	1019 kg	Ø 10 – 15 mm	20661	40,00 €
	600 mm	2080 kg	Ø 15 – 20 mm	20662	42,00 €
	600 mm	2080 kg	Ø 20 – 25 mm	20663	43,00 €
	1000 mm	2080 kg	Ø 25 – 30 mm	20664	47,00 €
	1250 mm	3059 kg	Ø 30 – 40 mm	20665	53,00 €
	1250 mm	4078 kg	Ø 40 – 50 mm	20666	58,00 €
	1500 mm	4996 kg	Ø 50 – 60 mm	20667	68,00 €
	1500 mm	4996 kg	Ø 60 – 70 mm	20668	80,00 €
	1500 mm	4996 kg	Ø 70 – 85 mm	20669	93,00 €
	1500 mm	5812 kg	Ø 85 – 100 mm	20670	106,00 €

ACCESSORIES – Optimal in combination with pulling rope, cable pulling grip and CW 800 E capstan winch

Item	Item no.	Rec. trade price
 <p>Connection swirl with swivel Ø 30 mm L 144 mm, stainless steel</p>	10176	190,00 €

All prices are ex-works 5303 - Thalgau - AUSTRIA - plus statutory taxes and duties. All price information represents non-binding price recommendations. Pricelist 2023. All illustrations are symbol photos. Typing and printing errors reserved.

CABLE GUIDE ROLLER

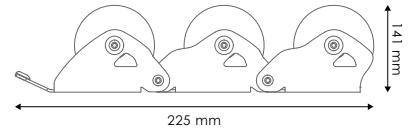
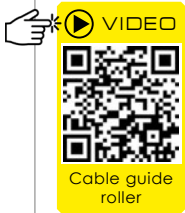

Cable guide roller can be used for shafts, cable trays, pillars, etc. to gently pull cables around corners with the least possible resistance. The high-quality aluminum heavy-duty rollers with integrated ball bearings and the stable powder-coated steel frame guarantee a long service life.

0 degrees 60 degrees 90 degrees 120 degrees 180 degrees



Item	Item no.	Rec. trade price
 <p>Cable guide roller – chain – 3 roll links Universally applicable for shafts, cable routes, pillars etc., load capacity 4.500 kg Roller-Ø 130 mm, max. cable diameter: Ø 100 mm Aluminium heavy-duty rollers, frame: CDP and powder coated</p>	10166	234,00 €
 <p>Cable guide roller – chain – 4 roll links Description see 3 roll links</p>	10199	312,00 €
 <p>Cable guide roller – chain – 5 roll links Description see 3 roll links</p>	10200	390,00 €
 <p>Cable guide roller – chain – 6 roll links Description see 3 roll links</p>	10201	467,00 €
  <p>Cable guide roller – shaft for shaft inlets or outlets , load capacity 4.500 kg Roller-Ø 130 mm, max. cable diameter: Ø 100 mm Aluminium heavy-duty rollers, frame: CDP and powder coated</p>	10157	79,00 €
  <p>Cable guide roller – shaft inside edge for shafts, shoulders or steps, load capacity 4.500 kg Roller-Ø 130 mm, max. cable diameter: Ø 100 mm Aluminium heavy-duty rollers, frame: CDP and powder coated</p>	10156	79,00 €
  <p>Cable guide roller – 90 degrees for corners and edges, load capacity 4.500 kg Roller-Ø 130 mm, max. cable diameter: Ø 100 mm Aluminium heavy-duty rollers, frame: CDP and powder coated, ergonomic aluminium carrying handle</p>	10153	152,00 €
  <p>Cable guide roller – 90 degrees 3 R for corners and edges, load capacity 2.500 kg Roller-Ø 130 mm, max. cable diameter: Ø 100 mm Aluminium heavy-duty rollers, frame: CDP and powder coated, ergonomic aluminium carrying handle</p>	10189	240,00 €

RM 80 Laser distance meter



POWERFUL LASER
up to 80 m



Front laser



Measures from 90° corner



Angle bracket straight



Carrying loop



Protective case



Technical data

Measuring range	0,05 m – 80 m	IP rating	IP 54
Measuring tolerance	± 1,5 mm auf 80m	Laser type	620 – 690 nm, < 1mW
Laser class	II	Dimensions (mm)	121 x 45 x 25
Measure range of tilt sensor	360°	Battery	AAA 2 x 1,5 V
Accuracy of tilt sensor	± 0,3 ° *	Battery life	up to 5000 measurings

* This is the typical value. Depending on the enviornment the deviation can rise slightly.

Technical data

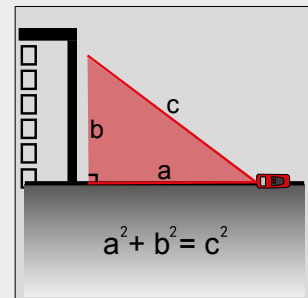
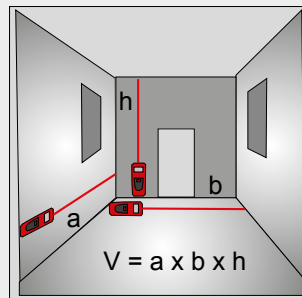
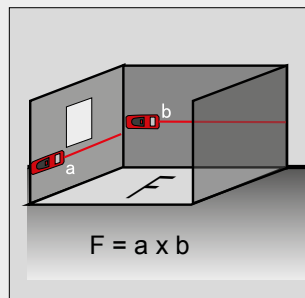
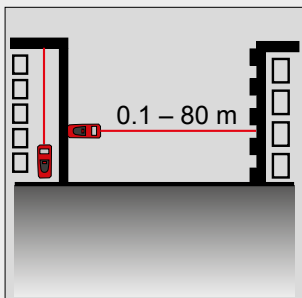

Item		Item no.	Rec. trade price
<p>Laser distance meter RM80</p> <ul style="list-style-type: none"> measures up to 80 m distance incl. angle- and inclination display extensive calculation functions storage of 99 measurings measures from 90° corner incl. protective case with belt loop 		10108	114,40€

All prices are ex-works 5303 - Thalgau - AUSTRIA - plus statutory taxes and duties. All price information represents non-binding price recommendations. Pricelist 2023. All illustrations are symbol photos. Typing and printing errors reserved.

METAL SPIRAL with special eyelet











Beginning: Special eyelet Ø 6 mm, pressed onto strand



Ending: Special eyelet Ø 6 mm, pressed onto strand

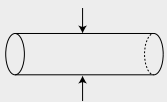



 3 times offset wound metal spiral

Rod	Rec. pipe diameter	Bending radius rod	Total breaking load - ending	Total breaking load - beginning
Ø				
4 mm	16 - 32 mm	25 mm	120 Kg	120 Kg

Item	Length	Item no.	Rec. trade price
	Metal spiral Ø 4 mm		
	with special eyelet		
	Total breaking load: 120 kg		
	10 m	30010	14,00 €
	15 m	30011	21,00 €
20 m	30012	26,00 €	
25 m	30013	32,00 €	
30 m	30014	39,00 €	

NYLON FISH TAPE







Beginning: starting spinner with eyelet Ø 6 mm, pressed onto strand



Ending: Special eyelet Ø 6 mm, pressed onto strand

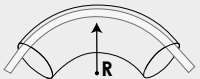

 25 mm

Rod	Rec. pipe diameter	Bending radius rod	TBL - ending	Total breaking load - beginning
Ø				
4 mm	16 - 25 mm	25 mm	110 Kg	110 Kg

Item	Length	Item no.	Rec. trade price
	Nylon fish tape Ø 4 mm		
	Total breaking load: 110 kg		
	5 m	20060	7,60 €
	10 m	20061	9,00 €
	15 m	20062	11,00 €
	20 m	20063	12,00 €
	25 m	20064	14,00 €
30 m	20065	15,00 €	

Page	EAN-Code	Item no.	Rec. trade price
28	9120045476163	10000	299,00 €
20	9120045472806	10013	140,00 €
20	9120045472813	10014	162,00 €
22	9120045473094	10016	119,00 €
22	9120045473100	10020	139,00 €
23	9120045473186	10042	24,00 €
23	9120045473179	10043	19,00 €
23	9120045473162	10044	20,00 €
23	9120045473155	10045	20,00 €
34	9120045473520	10047	331,00 €
34	9120045473537	10048	261,00 €
34	9120045473544	10050	384,00 €
34	9120045473551	10051	315,00 €
34	9120045473568	10052	252,00 €
34	9120045473575	10054	186,00 €
34	9120045473582	10055	279,00 €
34	9120045473599	10056	212,00 €
34	9120045473605	10057	306,00 €
34	9120045473612	10058	237,00 €
37	9120045473629	10059	312,00 €
37	9120045473636	10060	257,00 €
37	9120045473643	10061	339,00 €
37	9120045473650	10062	284,00 €
37	9120045473667	10063	370,00 €
37	9120045473674	10064	315,00 €
37	9120045473681	10065	435,00 €
37	9120045473704	10066	379,00 €
41	9120045473858	10076	442,00 €
41	9120045473865	10077	463,00 €
41	9120045473872	10078	482,00 €
41	9120045473889	10079	523,00 €
41	9120045473896	10080	559,00 €
41	9120045473902	10081	445,00 €
41	9120045473919	10082	475,00 €
41	9120045473926	10083	504,00 €
41	9120045473933	10084	559,00 €
41	9120045473940	10085	606,00 €
41	9120045473957	10086	637,00 €
41	9120045474428	10091	592,00 €
44	9120045474480	10092	736,00 €
44	9120045474497	10093	807,00 €
44	9120045474503	10094	909,00 €
44	9120045474510	10095	1 085,00 €

Page	EAN-Code	Item no.	Rec. trade price
44	9120045474527	10096	1 268,00 €
44	9120045474534	10097	1 369,00 €
46	9120045474749	10099	2 473,00 €
46	9120045474756	10100	2 726,00 €
46	9120045474763	10101	3 003,00 €
46	9120045474770	10102	3 256,00 €
46	9120045474787	10103	3 533,00 €
46	9120045474794	10104	3 818,00 €
52	9120045474893	10108	114,40 €
41	9120045475210	10110	725,00 €
50	9120045475364	10120	588,00 €
50	9120045475371	10121	657,00 €
50	9120045475388	10122	797,00 €
50	9120045475395	10123	889,00 €
12	9120045475647	10134	189,00 €
12	9120045475654	10135	219,40 €
11	9120045475616	10136	234,00 €
8	9120045475623	10137	114,40 €
48	9120045475630	10138	2 299,00 €
16	9120045475555	10139	524,00 €
16	9120045475562	10140	566,00 €
16	9120045475579	10141	608,00 €
12	9120045475609	10142	839,00 €
14	9120045475708	10147	135,00 €
48	9120045475715	10148	2 204,00 €
51	9120045476361	10153	152,00 €
30	9120045475777	10154	41,00 €
51	9120045476378	10156	79,00 €
51	9120045476385	10157	79,00 €
30	9120045475821	10159	41,00 €
14	9120045476439	10161	2 090,00 €
14	9120045476446	10162	2 610,00 €
14	9120045476453	10163	2 650,00 €
14	9120045476460	10164	2 690,00 €
51	9120045476521	10166	234,00 €
50	9120045475906	10167	415,00 €
50	9120045475913	10168	565,00 €
50	9120045475920	10169	369,00 €
9	9120045476545	10170	189,00 €
9	9120045476552	10171	305,00 €
2,6	9120045476583	10172	329,00 €
9	9120045475685	10174	148,00 €
32,50	9120045475999	10176	190,00 €

Page	EAN-Code	Item no.	Rec. trade price
6	9120045476910	10184	469,00 €
51	9120045477047	10189	240,00 €
25	9120045476729	10192	184,00 €
25	9120045477122	10193	169,00 €
25	9120045477139	10195	219,00 €
25	9120045477146	10196	117,50 €
25	9120045477153	10197	131,00 €
25	9120045477160	10198	156,50 €
51	9120045477214	10199	312,00 €
51	9120045477221	10200	390,00 €
51	9120045477238	10201	467,00 €
59	9120045476224	11117	181,00 €
21,35	9120045473353	11120	399,00 €
4	9120045475586	11137	643,00 €
4,17	9120045476392	11140	789,00 €
59	9120045476651	11142	175,00 €
2	9120045476897	11143	379,00 €
4	9120045477177	11146	659,00 €
36	9120045473711	20002	129,00 €
28	9120045472585	20004	178,00 €
28	9120045470161	20010	8,00 €
28	9120045470253	20020	9,00 €
28	9120045470307	20025	9,00 €
28	9120045470376	20032	9,00 €
28	9120045470451	20040	9,00 €
22	9120045473049	20059	21,00 €
53	9120045472523	20060	7,60 €
53	9120045472530	20061	9,00 €
53	9120045472547	20062	11,00 €
53	9120045472554	20063	12,00 €
53	9120045472561	20064	14,00 €
53	9120045472578	20065	15,00 €
27	9120045474053	20108	7,00 €
26	9120045474077	20116	7,80 €
26	9120045474091	20119	8,00 €
23,26	9120045473209	20238	29,00 €
21	9120045472820	20240	110,00 €
21	9120045472837	20241	126,00 €
21	9120045472844	20242	144,00 €
36	9120045473384	20250	22,00 €
36	9120045473391	20251	24,00 €
38	9120045473407	20252	39,00 €
28	9120045472868	20253	17,00 €

Page	EAN-Code	Item no.	Rec. trade price
23	9120045473032	20260	9,00 €
23	9120045473018	20261	6,80 €
23	9120045473001	20262	10,00 €
32	9120045473728	20266	40,00 €
32	9120045473735	20267	42,00 €
32	9120045473742	20268	43,00 €
32	9120045473759	20269	45,00 €
31	9120045473292	20272	26,00 €
31	9120045473308	20273	29,00 €
31	9120045473315	20274	33,00 €
36,38	9120045474350	20278	42,00 €
36,38	9120045473230	20279	18,00 €
36,38	9120045474800	20280	15,00 €
39	9120045473766	20300	166,00 €
35,38	9120045474084	20303	8,00 €
35	9120045473438	20311	80,00 €
35	9120045473445	20312	94,00 €
35	9120045473452	20313	110,00 €
35	9120045473469	20314	127,00 €
35	9120045473476	20315	157,00 €
39	9120045473261	20316	12,00 €
38	9120045473483	20317	103,00 €
38	9120045473490	20318	125,00 €
38	9120045473506	20319	144,00 €
38	9120045473513	20320	182,00 €
39	9120045473414	20321	14,00 €
36	9120045473254	20322	11,00 €
36	9120045473421	20323	14,00 €
28	9120045473780	20333	8,00 €
31	9120045474114	20365	18,00 €
31	9120045474121	20366	19,00 €
31	9120045474138	20367	29,00 €
42	9120045474145	20368	126,00 €
42	9120045474152	20369	142,00 €
42	9120045474169	20370	161,00 €
42	9120045474176	20371	201,00 €
42	9120045474183	20372	237,00 €
42	9120045474190	20373	140,00 €
42	9120045474206	20374	166,00 €
42	9120045474213	20375	193,00 €
42	9120045474220	20376	240,00 €
42	9120045474237	20377	300,00 €
42	9120045474244	20378	340,00 €

Page	EAN-Code	Item no.	Rec. trade price
43	9120045474268	20379	10,00 €
43	9120045474275	20380	14,00 €
43	9120045474282	20381	10,00 €
45,47	9120045474299	20382	39,00 €
45,47	9120045474305	20383	27,00 €
43	9120045474312	20384	46,00 €
43	9120045474329	20385	51,00 €
44	9120045474541	20386	508,00 €
45,47	9120045474336	20387	35,00 €
32	9120045474343	20388	22,00 €
36	9120045474374	20402	178,00 €
39	9120045474367	20403	224,00 €
45,47	9120045474398	20404	25,00 €
43	9120045474404	20405	320,00 €
45,47	9120045474411	20409	23,00 €
27	9120045474107	20411	7,00 €
43	9120045474251	20412	14,00 €
42	9120045474442	20414	273,00 €
45	9120045474473	20416	399,00 €
44	9120045474558	20417	519,00 €
44	9120045474565	20418	646,00 €
44	9120045474572	20419	808,00 €
44	9120045474589	20420	954,00 €
44	9120045474596	20421	1 111,00 €
45	9120045474602	20422	12,00 €
45	9120045474985	20423	17,00 €
45	9120045474626	20424	59,00 €
23,27	9120045474633	20427	6,90 €
23,27	9120045474640	20428	6,90 €
32	9120045474657	20436	62,00 €
32	9120045474664	20437	66,00 €
32	9120045474671	20438	70,00 €
32	9120045474688	20439	79,00 €
32	9120045474695	20440	93,00 €
32	9120045474701	20441	110,00 €
40	9120045474718	20442	99,00 €
43,45	9120045474725	20443	5,80 €
23	9120045474831	20455	17,00 €
23	9120045474848	20457	12,00 €
26,35	9120045474855	20460	29,00 €
42	9120045474879	20461	106,00 €
45	9120045474886	20462	112,00 €
22	9120045475081	20468	20,00 €

Page	EAN-Code	Item no.	Rec. trade price
26	9120045475098	20475	23,00 €
26	9120045475104	20476	46,00 €
18	9120045475180	20481	67,00 €
18	9120045475197	20483	6,60 €
18	9120045474930	20484	9,30 €
18	9120045474947	20485	46,00 €
24,36	9120045474954	20487	9,10 €
18	9120045474961	20488	137,00 €
47	9120045474978	20489	172,00 €
46	9120045474992	20490	55,00 €
46	9120045475005	20491	999,00 €
46	9120045475012	20492	1 235,00 €
46	9120045475029	20493	1 500,00 €
46	9120045475036	20494	1 762,00 €
46	9120045475043	20495	2 020,00 €
46	9120045475050	20496	2 324,00 €
47	9120045475067	20497	1 591,00 €
47	9120045475203	20498	56,00 €
18	9120045475241	20509	7,80 €
27	9120045475265	20522	7,10 €
27	9120045475272	20523	8,20 €
50	9120045475296	20525	330,00 €
50	9120045475302	20526	325,00 €
50	9120045475319	20527	251,00 €
18	9120045476156	20559	335,00 €
18	9120045476149	20560	291,00 €
42	9120045476194	20562	404,00 €
18	9120045476132	20593	208,00 €
18	9120045476088	20606	21,50 €
18	9120045476064	20607	16,50 €
18	9120045476019	20608	29,00 €
12	9120045475678	20609	29,00 €
12	9120045476095	20610	31,00 €
28	9120045476118	20611	54,00 €
18	9120045476026	20612	54,00 €
21	9120045476002	20613	54,00 €
23	9120045476101	20614	24,00 €
50	9120045475838	20615	264,00 €
50	9120045475845	20616	346,00 €
50	9120045475852	20617	495,00 €
50	9120045475869	20618	578,00 €
50	9120045475876	20619	173,00 €
50	9120045475883	20620	254,00 €

All prices are ex-works 5303 - Thalgau - AUSTRIA - plus statutory taxes and duties. All price information represents non-binding price recommendations. Pricelist 2023. All illustrations are symbol photos. Typing and printing errors reserved.

Page	EAN-Code	Item no.	Rec. trade price
50	9120045475890	20621	127,00 €
48	9120045475722	20622	139,00 €
12	9120045475661	20623	73,00 €
30	9120045475739	20624	14,00 €
30	9120045475746	20625	14,50 €
30	9120045475753	20626	15,00 €
30	9120045475760	20627	15,50 €
30	9120045475784	20628	14,00 €
30	9120045475791	20629	14,50 €
30	9120045475807	20630	15,00 €
30	9120045475814	20631	15,50 €
8,11	9120045476071	20632	10,00 €
42,45	9120045476187	20646	31,00 €
48	9120045476613	20657	190,00 €
48	9120045476620	20658	157,00 €
32	9120045476248	20661	40,00 €
32	9120045476255	20662	42,00 €
32	9120045476262	20663	43,00 €
32	9120045476279	20664	47,00 €
32	9120045476286	20665	53,00 €
32	9120045476293	20666	58,00 €
32	9120045476309	20667	68,00 €
32	9120045476316	20668	80,00 €
32	9120045476323	20669	93,00 €
32	9120045476330	20670	106,00 €
14	9120045476484	20692	504,00 €
14	9120045476491	20693	546,00 €
14	9120045476507	20694	588,00 €
9	9120045476538	20696	53,00 €
7	9120045475326	20706	33,00 €
7	9120045475333	20707	13,00 €
7	9120045475340	20708	54,00 €
14	9120045476644	20711	135,00 €
7	9120045476637	20714	38,00 €
7	9120045476705	20738	17,00 €
7	9120045476712	20739	39,00 €
26	9120045477184	20816	46,50 €
26	9120045477191	20817	54,60 €
26	9120045477207	20818	66,00 €
26	9120045477276	20819	36,80 €
26	9120045477269	20824	6,00 €
26	9120045477252	20825	4,20 €
26	9120045477283	20826	30,50 €

Page	EAN-Code	Item no.	Rec. trade price
26	9120045477290	20829	4,00 €
7	9120045477337	20849	19,90 €
7	9120045477344	20850	22,00 €
7	9120045477351	20851	22,00 €
23	9120045473193	30009	22,00 €
53	9120045471977	30010	14,00 €
53	9120045471984	30011	21,00 €
53	9120045471991	30012	26,00 €
53	9120045472004	30013	32,00 €
53	9120045472011	30014	39,00 €
29	9120045472028	30017	26,00 €
29	9120045472035	30018	34,00 €
29	9120045472042	30019	42,00 €
29	9120045472059	30020	50,00 €
29	9120045472066	30021	54,00 €
24	9120045472073	30027	16,60 €
24	9120045472080	30028	17,90 €
24	9120045472097	30029	21,50 €
24	9120045472103	30030	25,00 €
31	9120045472158	30039	21,00 €
31	9120045472165	30040	23,00 €
31	9120045472172	30041	35,00 €
24	9120045472189	30042	29,60 €
24	9120045472196	30043	34,30 €
27,36	9120045472240	30050	8,20 €
29	9120045474466	30054	19,00 €
19,43	9120045472301	30063	7,40 €
27	9120045472318	30064	8,90 €
36,38	9120045472356	30067	20,00 €
27,36	9120045472387	30070	6,20 €
21	9120045473841	30146	35,00 €
36,38	9120045473025	30208	4,80 €
23	9120045473124	30210	4,20 €
23	9120045473056	30236	5,30 €
22	9120045472998	30239	20,20 €
27	9120045474862	30467	4,40 €

Version: 04-2010

Area of applicability:

All deliveries and services of Runpotec GmbH, hereinafter referred to as Runpotec in abbreviated form, shall take place on the basis of the general terms and conditions of business at hand. Any deviating terms and conditions of business of the customer shall not become part of the contract, also in case that their validity is named as a condition for the conclusion of the business transaction.

II Offer and order:

1. All offers shall be subject to confirmation and non-binding.
2. The contract shall come into existence either by means of a written order confirmation or by delivery of the goods. In the latter case, the invoice shall also apply as the order confirmation.
3. The details concerning the services of Runpotec contained in price lists, in catalogues on the Internet and other advertising media do not contain any information which defines services as defined in § 922 Paragraph 2 of the Austrian General Civil Code (ABGB).
4. Amendments and additions to the contract, including the general terms and conditions of business, shall require written form to take legal effect. The same shall also apply in respect of deviation from the written form clause itself. Oral ancillary agreements shall not be effective.

III. Prices and payment terms

1. The prices named in catalogues, prospectuses, mailing letters, price lists and illustrations are non-binding and subject to confirmation. The prices are exclusive of value added tax and customs duties, as well as any shipping costs due.
2. As a rule, deliveries shall only be made with payment on delivery or prepayment. Bills of exchange and cheques shall not be considered as payment and shall only be accepted under notice of provisional receipt.
3. In case of payment delay, the Customer shall be obliged to pay default interest of 10% per annum.
4. The Customer shall pay a fee of up to € 20 for each warning to cover the expenses incurred. In addition, the reasonable costs of engaged credit collection agencies or lawyers shall be paid by the Customer.
5. The Customer shall not be entitled to set off with claims of any type, unless these are expressly recognised by Runpotec in writing or have been recognised by declaratory judgement by a court.

IV. Delivery

1. Delivery times shall be complied with as best as possible, but shall be non-binding. Delivery delays shall therefore not entitle the Customer to assert claims, regardless of under which legal title. Circumstances which are independent of and cannot be influenced by Runpotec, such as operational disruptions, interventions by the authorities, delays of subcontractors, labour conflicts etc. shall extend the delivery deadline by the duration of the hindrance and shall entitle Runpotec to rescind the contract, to the exclusion of damages claims, warranty claims and error appeal claims. This shall also apply if the events occur at a time in which Runpotec is already in default.
2. The dispatch or transportation shall take place at the expense and risk of the Customer. In the absence of specific instructions of the Customer, the delivery shall take place at our best discretion and without a guarantee concerning the choice of the best and cheapest shipping. Packaging material will not be accepted for return. The transfer of risk from Runpotec to the Customer will also take place on handover to the shipping company in respect of goods which are delivered free house. Insurance will only be concluded by means of written order by the contracting partner and this shall be at their expense.
3. Regardless of the place of delivery and/or performance and the covering of possible transportation costs, 5303 Thalgau, Austria is hereby agreed as the place of performance on the part of the Customer.
4. Any possible export and customs permits, currency permits or similar permits shall be obtained by the Customer at its own expense. The Customer shall be obliged to hold Runpotec free and harmless from all customs expenses. In case of other liability in respect of tax stipulations, the Customer shall be obliged to return all export and customs papers to Runpotec in the original. Runpotec shall not incur liability in respect of the permissibility of the export of the goods and their conformity with the legal and technical regulations of the importing country, and shall also not be responsible for the goods conforming to the state of technology in the importing country.
5. In case of delay in acceptance on the part of the Customer, Runpotec shall be entitled to either to request performance and the full fee or to rescind the contract and demand a cancellation fee of 50% of the value of the goods. A possible claim for damages which goes beyond this shall not be affected thereby.

VI. Retention of title

1. The goods shall remain the property of Runpotec until full payment of all claims. During the existence of the retention of title, the Customer shall not be entitled to sell, process or pledge the goods or to dispose of them in any other way.
2. The assertion of the retention of title shall not require rescission, shall not be deemed as rescinding the contract and shall not release the Customer from its obligations, in particular that of payment of the purchase price.

3. In order to inspect the goods which are subject to retention of title, the Customer shall grant access to its operations at all times. Should the Customer enter default concerning its payment obligations, should bankruptcy proceedings be opened against its assets or should it breach other contractual duties, Runpotec shall be entitled to demand surrender of the goods subject to retention of title, to collect these and to enter the premises of the Customer during this process. In case of assertion of the retention of title, the Customer shall be obliged to pay any reduction of value in respect of the goods and to pay Runpotec a reasonable fee for their use.

VII. Guarantee and liability

1. Should the Customer be an entrepreneur, it shall be obliged to immediately make a complaint regarding defects in writing, at the latest within a week of handover, and in case of other lost of claims of any kind giving details of the defect in writing. Defect complaints shall not entitle the Customer to withhold the purchase price in part or in full.
2. The warranty period in relation to consumers shall be two years, and for entrepreneurs, six months.
3. The Customer shall provide Runpotec with the opportunity to check the defect. In case of a defect, Runpotec shall be entitled to defend a possible price reduction claim by means of improvement or a replacement delivery. Runpotec shall be entitled to deal with the defect itself or by a third party on site or to request return of the goods for the purpose of improvement. Dealing with the defect on the part of the customer by means of a third party company shall only be permitted if Runpotec does not deal with the defect within a reasonable deadline, despite a demand note.
4. Warranty claims shall therefore only exist if the device is used in accordance with the operating instructions and in compliance with all intended operating conditions, and the defect arises in normal use. The warranty does not cover the correction of defects which are due to external influences, operating error or use of the device together with other equipment or accessories which are not provided by Runpotec and whose compatibility with the device which forms the subject matter of the contract was not expressly approved in writing.
5. Damages claims for whatever legal reason, in particular due to delay, impossibility, positive breach of obligation, fault at the time of conclusion of the contract, consequential damage caused by defects and error arising out of a defective delivery or service shall be excluded, unless these are caused by intent or gross negligence on the part of Runpotec. In any case, damages claims of the Customer shall be limited to the simple net value of the goods. Liability for lost profit or consequential loss of the Customer of whatever type shall be excluded. The Customer shall provide proof of the presence of fault and causation.
6. The assignment of warranty and damages claims shall not be permitted.
7. The Customer hereby expressly waives the assertion of damages claims for property damage under the title of the Austrian Product Liability Act (Produkthaftungsgesetz) which it suffers within the framework of its company. Should the Customer sell the device to other companies, the Customer shall be obliged to bind its contractual partners and any further commercial contractual partners to this waiver. To the extent that the Customer omits to do this, the Customer shall be obliged to indemnify and hold harmless Runpotec. Should the Customer incur liability due to the Austrian Product Liability Act (Produkthaftungsgesetz), it shall waive any recourse in relation to Runpotec. In case of the presence of the requirements of § 933 b of the Austrian General Civil Code (ABGB), the Customer shall be entitled to obtain recourse within two months in relation to Runpotec, however only if such an assertion takes place before a court within three years of delivery.

VIII Place of jurisdiction and applicable law:

1. Austrian law shall apply between the contracting parties to the exclusion of the UN Convention on the International Sale of Goods.
2. The general terms and conditions of business shall only apply in relation to consumers to the extent that mandatory provisions of the Austrian Consumer Protection Act (Konsumentenschutzgesetz) do not prevent this.
3. The competent court for 5303 Thalgau, Austria is hereby exclusively agreed as the place of jurisdiction for all legal disputes concerning the concluded contract. However, Runpotec shall also be entitled to bring lawsuits at other courts for which a statutory place of jurisdiction of the Customer is present.

IX General:

1. Runpotec shall be entitled to save and process data of the contracting partner in accordance with the Austrian Data Protection Act (Datenschutzgesetz) within the framework of the business dealings.
2. Should any individual points of these terms and conditions of business or the negotiated contract be ineffective, this shall not affect the validity of the remaining provisions. In place of the ineffective provision, a clause which comes closest to its sense and purpose shall be deemed to be agreed.

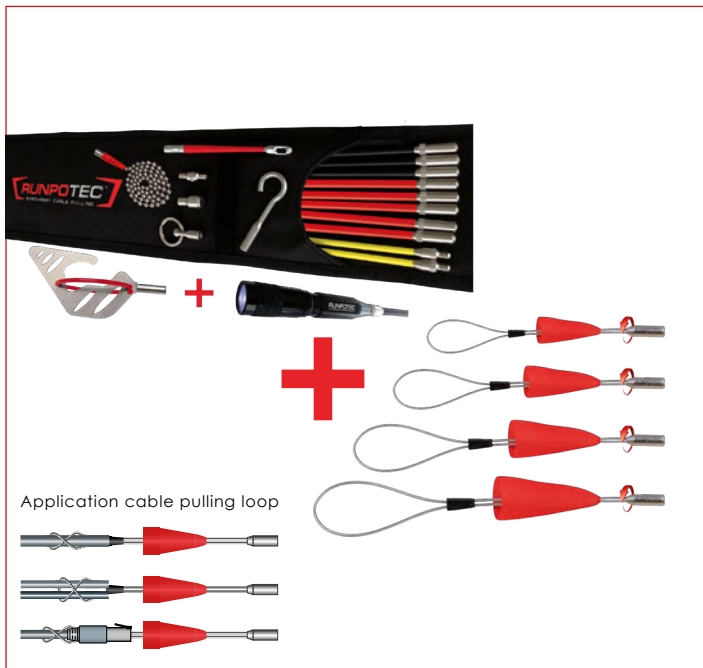

PROMOTION DESCRIPTION

RUNPOSTICKS - Comfort package + Cable pulling loop with thread RTG 6

1 x RUNPOSTICKS - Comfort package 19-parts

Field of application: suspended ceilings, cable ducts, hollow walls usw...

1 x Cable pulling loop with thread RTG Ø 6 mm - set of 4

Field of application: to protect pre-assembled cables incl. plugs or to protect several cables at the same time.

For more information see product videos.

€ **181,-**
plus tax

RUNPOSTICKS - Cable pulling loop - offer
RUNPOTEC Item no. 11117

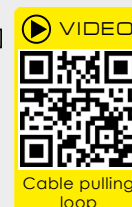

PROMOTION DESCRIPTION

RUNPO 5 Profi cable pulling system + Cable pulling loop with hook

1 x RUNPO 5 - 30 m incl. 2 x RG7 - Guiding head with swivel

1 x Cable pulling loop with hook - set of 4

Field of application: To pull pre-fabricated cables incl. plugs in a protected manner. For pipes with an inner diameter of 14 mm or more and non-guided lines.

For more information see product videos.

INSTEAD OF € 203,00

€ **175,-**
plus tax

RUNPO 5 - Cable pulling loop - offer
RUNPOTEC Item no. 11142



INTRODUCTORY PRICE

RM35 cable length measuring device

The RM35 is a digital cable length measuring device with which cables, single wires, ropes, pipes or hoses with a diameter of Ø 2 mm to Ø 32 mm can be measured precisely. It is splash-proof and dust-proof, extremely shock-resistant and therefore ideally suited for the construction site.

For more information see product videos.

INSTEAD OF € 399,90

€ **329,-**
plus tax

X BOARD XB 500 - Introductory price
RUNPOTEC Item no. 10172



EXTRA STRONG, up to max. 800 kg, has the pulling power of approx. 10 people

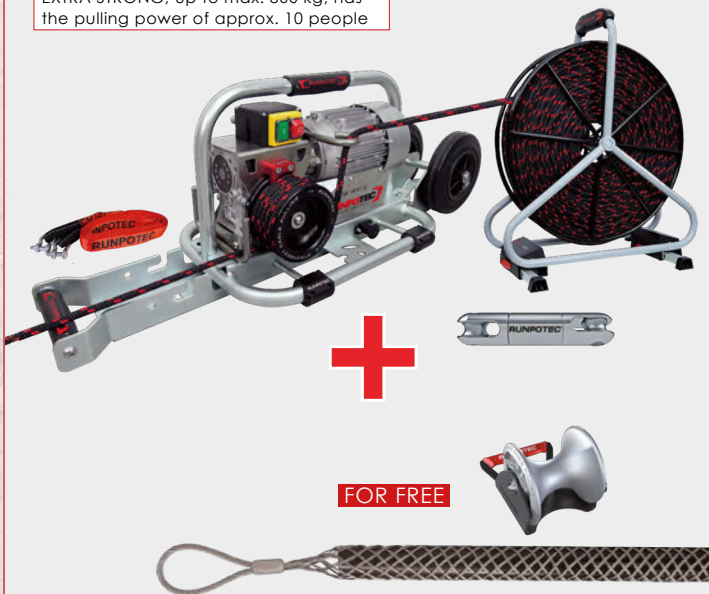

PROMOTION OFFER!

Buy **1x capstan winch + 1x pulling rope + 1x connection swirl**, get **1x Cable pulling grip + 1x Cable guide roller – shaft** for free!

- CW 800 E capstan winch incl. trolley mounting rail and strap for horizontal cable pulling (230 V / 50 Hz - 0,75 kWh / 5,1 A)
- Polyester cable pulling rope incl. steel reel
- Connection swirl with swivel Ø 30 mm
- Cable pulling grip with loop, made of high quality, galvanised steel double weave

See page 48 – 50 for details

Further information is available at www.runpotec.com or in the product video

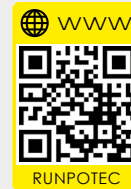

Cable guide roller

High performance guide roller with integrated ball bearings. Heavy duty rollers made from aluminium, CDP/ powder coated frame, ergonomic aluminium carrying handle, Roller-Ø 130 mm, max. cable-Ø 100 mm

Load capacity 4.500 kg - Item No. 10166, 10157, 10156 and 10153
Load capacity 2.500 kg - Item No. 10189



Cable guide roller	Item no.	Rec. trade price
Chain 3-parts (universally applicable)	10166	234,00 €
Shaft (for insert cables into or out of shafts)	10157	79,00 €
Shaft inside edge (for shafts or stages)	10156	79,00 €
90 degrees (for shafts or stages)	10153	152,00 €
90 degrees 3R (for corners and edges)	10189	240,00 €



Cable guide roller chain - 3-parts



Cable guide roller Shaft



Cable guide roller Shaft Inside edge



Cable guide roller 90 degrees- 3 R



Cable guide roller 90 degrees



Irlachstrasse 31
5303 Thalgau / Austria
Phone: +43 6235 20335-0
Fax: +43 6235 20335-35

office@runpotec.com
www.runpotec.com

Newsletter
Sign up



Scan the QR code, subscribe and be informed immediately about new products and promotions.

