

PRODUCT
CATALOG

22
23



ABOUT US

Our mission: We protect the world's most critical connections to provide stronger and more reliable networks for everyone.

We've designed, manufactured and supplied passive components for fiber networks since 1990. Everything we do at Micos Telcom is designed to provide efficient, simple and innovated solutions to solve complicated tasks. We take extra care and steps to ensure our certified products with advanced functionality and new features are easy for our customers to use.

Our production facilities utilise the latest technologies and equipment for metal and plastics processing. We manufacture Fiber Distribution Products and Data Cabinets and offer a range of extended assembly services. We hold accreditations for ISO 9001, ISO 14001 and ISO 45001.

Our portfolio contains more than 1,000 items. We strive to fully optimize solutions to meet the high standards of our global customers' expectations. The Fiber Distribution Products and Data Cabinets are manufactured in the European Union.

Our products are used extensively in the many FTTx scenarios - externally / internally and for business or residential scenarios. We provide a complete FTTx solution portfolio including Fiber Access Terminal Boxes, Fiber Optic Boxes, Fiber Distribution Hubs, Fiber Optic Closures, Fiber Optic Patch Panels, Fiber High Density Cabinets and Data Cabinets. We've also created the unique FibeRoad™ System, which can be used across all points of optical networks from small closures to large cabinets and will make deployment and maintenance a routine rather than challenge.

We aspire to see these products in use worldwide and currently supply them to over 70 countries. That's something that we are incredibly proud of, and we take aim to build on that moving forward.

In 2019, we've become a part of the Preformed Line Products (PLP) company, a worldwide designer, manufacturer and supplier of fiber optic and copper splice closures, high-speed cross-connect devices and high-quality cable anchoring / control hardware, established in 1947.

We and PLP have strengthened our position as one of the world's leading suppliers of passive components for fiber networks and critical infrastructure.

Since 2020, we've developed and implemented a long-standing Center of Excellence for telecommunications and FTTx optical networks. Our customers benefit from our significant research and development in conjunction with our own production facilities. We utilise our considerable cross-discipline technical expertise and resources to offer special and completely new technical solutions according to our customers' requirements - from product development and prototyping to testing and putting into operation.

We've 18 workplaces with the highest cleanliness requirements, final inspection of quality and complex solutions for our customers' projects. Thanks to this service, our customers gain a couple of advantages - time and cost savings, elimination of mistakes and increased quality.



22
23



TIME-TESTED Products

For Stronger & Consistent
Optical Networks

32 YEARS
11 680 DAYS
280 320 HOURS
16 819 200 MIN.
1 009 152 000 SEC.



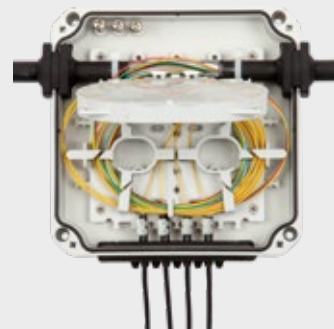
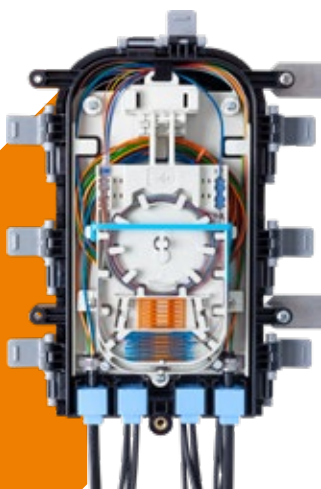
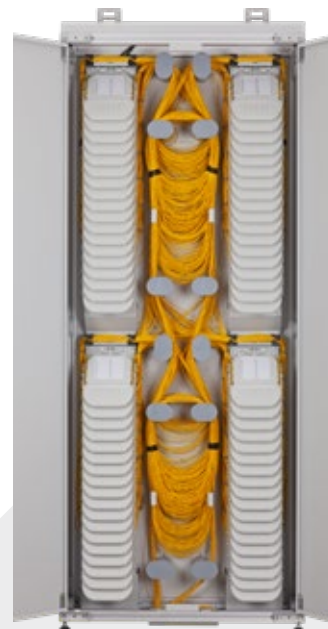



Fiber Distribution Products

Fiber Access Terminal Boxes

14-15

ORM 1	14		
ORM 2	15		

Fiber Optic Boxes

16-39

MTeH MINI	16		●
MTeH EASY	17		
MTeH UNI	18		
ORM 3 FA	19		
ORM 3 L/2	19		
ORM 3 L/4	20		
ORM 3 SL 12S	20		
ORM 3 SH 24S	20		
ORM 5	21		
MDB XS	22		●
MDB S	26		●
MDB M	30		●
MAB	34		●
FTTA 12/24/48	36		●
MDB FA 144/192/288S	37		
MDB FA 24/48, 48/96, 72/144	38		
ORU 1	39		
ORU 2	39		
ORU 3	39		

Fiber Distribution Hubs

40-47

SNM 48 SIS	40		
SNM 72 VS SIS	40		
SNM 144 VS SIS	40		
ORM 16 SDF SIS	41		
MDP OZ 144/288/432S	42		
MDP OZ 24/48, 48/96, 72/144	43		
ORU 1 SIS	44		
ORU 2 SIS	44		
ORU 3 SIS	44		
ORU 1 SDF SIS	45		
ORU 5 SDF SIS	46		

Fiber Optic Closures

48-61

COYOTE® DTC	48		
COYOTE® DTC4/DTC6	48		
COYOTE® LCC	48		
COYOTE® IN-LINE RUNT	49		
COYOTE® HD DOME	49		
ROMIE	49		
COYOTE® STP-JR	50		
COYOTE® STP-MD	52		
COYOTE® STP-XL	54		●
COYOTE® DOME SFMS	58		●

Underground Chambers

62-63

MUC 160	62		
MUC 250	62		
MUC Cube 320	63		

▶ Fiber Optic Patch Panels	64-68	
UHD ORMP 1U/2U	64	●
ORMP 1U	65	
ORMP 2U	65	
ORMPV 1U	66	
ORMPV 2U	66	
ORMPV 3U	66	
ORMPM 3U/144	67	
▶ Fiber High Density Cabinets	69-74	
MDO 300	69	●
MDO 600	70	●
MDO 900	71	●
MDO Subrack	72	●
ORSL EE	73	
ORSL AP 300	74	
ORSL AP 600	74	
▶ Fiber Optic Accessories		
▶ FiberRoad™ System	75	
▶ Fiber Optic Trays	76-81	
KM 4	76	
KM 5	77	●
KM 6	78	
KM 7	79	●
SAFeTNET System	80	
SFMS System	80	
KM 1	81	
KM 2	81	
EC2	81	
▶ Optical Splitters	82	
Cable Splitter	82	
PLC Splitter	82	
▶ Patchcords and Fiber Optic Pigtails	83	
▶ Optical Adapters	83	
▶ Miscellaneous	84-86	
Splice Holders and Heatshrinks	84	
Splice Holders for SFMS Trays	84	
Grommets	85	
Express Port	86	
Ranging Rings and Protective Tubes	86	
Fixing Material	86	
▶ Data Cabinets, Data Racks		
▶ Wall-Mounted Data Cabinets	87-88	
MNORS	87	
MNS	88	
MBS	88	
▶ 19" Racks	89-91	
MSS	89	
MSS 22U/55	90	
SAP 4 1500/2000	91	
▶ Accessories for Data Cabinets, Data Racks	92-93	





	INDOOR USE	OUTDOOR USE	MAX. CAPACITY OF SPLICES	MAX. CAPACITY OF CONNECTORS SC/LC
	●		144/288	72/144, 144/288
●	●		48	24/48
●	●		72	72/72
●	●		48	36/-
●	●		96	96/-
●	●		288	144/288
●	●		288	144/288
●	●	●	1,728	576/1,152
●	●	●	1,728	576/1,152
●	●	●	3,456	1,152/2,304
●	●	●	864	288/576
●	●		44U	44U
●	●		42U	42U
●	●		42U	42U
		●		
●	●	●	24	-
●	●	●	24	12/24
●	●	●	24	-
●	●	●	16	8/16
		●	6/12	-
		●	6/12	-
		●	12	-
		●	12	-
		●	24	-
	●			
	●			
	●			
	●			
		●		
		●		

Explore Our Indoor and Outdoor FTTx Solutions

None of us wants to spend too much time looking for products. Neither we nor our customers. We have thought about how to make your life easier and prepared the complete Solutions. Using them, you no longer have to search for individual products. Thanks to the Solutions, you can see at glance all the products you will need.

How to Work with the Solutions?

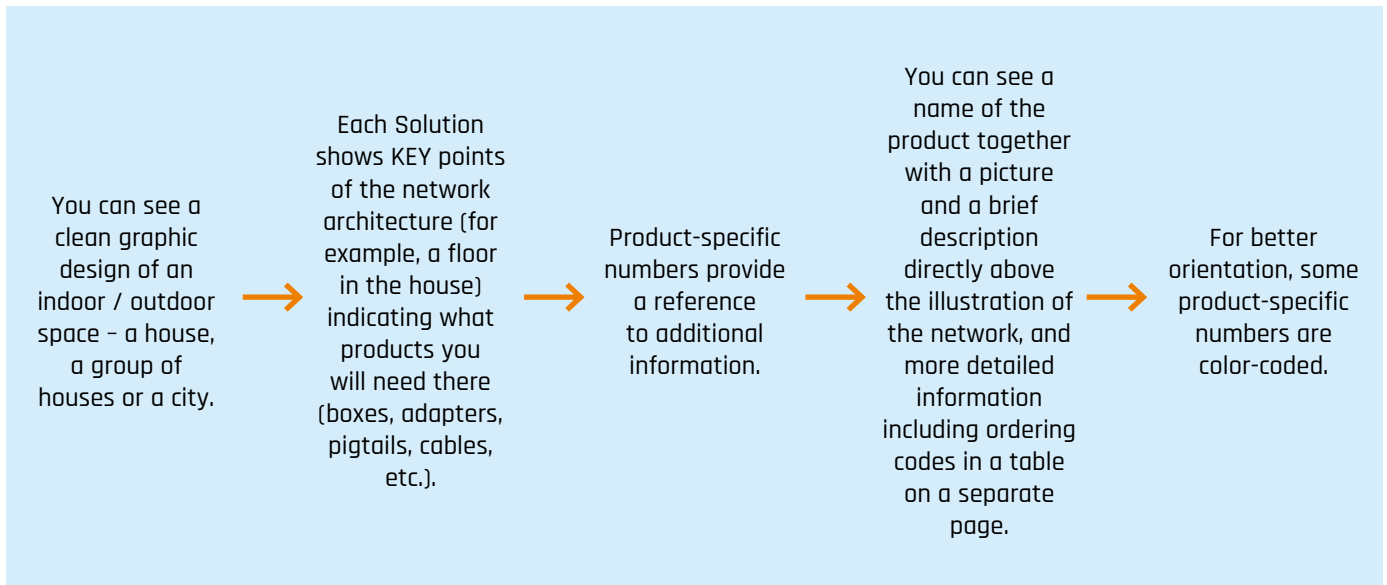

Central Office Solution

The Central Office Solution using the Fiber High Density Cabinets MDO and the FibeRoad™ System is very variable and can be adapted to meet the majority of fiber optic network requirements. All the cabinet parts, such as the side panels, the door or the subracks, are optional accessories and can be gradually added to meet the current network requirements.

YOU CAN VIEW THE SOLUTION ON THE LINK:

https://www.micostelcom.com/data/Central_Office_Solution_by_Micos_Telcom.pdf



FibeRoad™ Solution

The FibeRoad™ Solution shows where the FibeRoad™ System can be used and installed. The System supports all types of fiber optic networks and helps create all configurations of fiber distribution and direct termination of connectors.

YOU CAN VIEW THE SOLUTION ON THE LINK:

https://www.micostelcom.com/data/FibeRoad_Solution_by_Micos_Telcom.pdf



FTTH GPON Spliceless Solution

The FTTH GPON Spliceless Solution gives an idea of designing an inbuilding distribution networks structure by using floor boxes without splicing fibers, qualified labor force and expensive equipment.

YOU CAN VIEW THE SOLUTION ON THE LINK:

https://www.micostelcom.com/data/FTTH_GPON_Spliceless_Solution_by_Micos_Telcom.pdf



FTTH RISER Solution with Floor Box

The FTTH RISER Solution with Floor Box shows an easy and popular way of constructing FTTH networks by using RISER cable. Connecting customers goes very quickly, without splicing, just by placing patchcord between floor box and customer's premises.

YOU CAN VIEW THE SOLUTION ON THE LINK:

https://www.micostelcom.com/data/FTTH_RISER_Solution_with_Floor_Box_by_Micos_Telcom.pdf



FTTH Facade Solution

The FTTH Facade Solution offers a simple way of optical infrastructure installation, which fully eliminates construction works inside buildings. It's suitable especially for two-storey houses.

YOU CAN VIEW THE SOLUTION ON THE LINK:

https://www.micostelcom.com/data/FTTH_Facade_Solution_by_Micos_Telcom.pdf



Case Studies

Case studies are very important for our clients and customers as they particularly prove that our products are working and functional. It is then easier for our customers to imagine how to make their current projects better. For us, preparing case studies is as important as the expansion of our research and development center or manufacturing. They provide us with feedback on how our customers work with our products and how they install them in their networks. And we would like to share this experience through “best practices”.

Our pilot case study proves that the entire fiber optic network can only be built on Micos Telcom products. The case study **“Building a Fiber Optic Network with the GPON Technology Using the Micos Telcom Products”** shows a pilot project of the PVfree.net company in a small municipality in the Czech Republic. It was a standard NGA network, passive with 2-stage splitting and based on the GPON technology.

“This is our first cooperation with Micos Telcom and its products. We appreciate the carefully prepared catalog, we can immediately see the maximum capacity of each product. I also participated in a training session directly at Micos Telcom, led by Mr. Titz. I also visited their showroom several times before the cooperation started. So, it was more or less a safe bet then. Today we can see how Micos Telcom products are more durable compared to the products we have tried in the past, and spiders, slugs and other vermin cannot get into the parts that should remain clean. One of the things I also like about the products is their aluminium splitter holder, the cassette mandrel and the tilting mechanism,” said Vladimír Palik, Chief Designer.



Another case study **“How to Build a High Quality Regional Fiber Network with SMART Elements and Great Future Potential”** focuses on a small Czech region and the BurgNet company, which decided to build a high quality fiber optic network without compromise. The company chose Micos Telcom as the passive component supplier and also the consultant for the entire network building process. The network was based on FTTH architecture and point-to-point topology with no splitters.

“I have been working with Micos Telcom products for over 10 years, ever since I started building the fiber network. I know that there are both cheaper and more expensive alternatives, but I wouldn't choose any of them in terms of quality and suitability. I've had the opportunity to get my hands on other competing products at various trade fairs, but I don't think this is what you should save money on. When you buy Micos Telcom products, you get completely turnkey solutions that are functional and nice to work with. Moreover, these products add value to the entire network,” said Zbyněk Burget, the Owner of BurgNet.



ORM 1

The optical socket ORM1 is designed for termination of an optical network via 2–4 optical fibers in a customer terminal point. It can be connected to a PC, different peripheral equipment or to another equipment via optical patchcords. It is designed for indoor wall mounting.

- ▶ Capacity of 4 optical connectors
- ▶ Connector holder SC simplex or LC duplex
- ▶ Maximum capacity is 4 optical splices
- ▶ Attractive design for indoor usage
- ▶ Installing on a surface or flush-mounting box
- ▶ Simple optical management
- ▶ Direct fiber termination by a connector
- ▶ Standard socket dimensions
- ▶ Input possibility of fiber with connector
- ▶ Use for fibers G.657

TECHNICAL SPECIFICATIONS

Ingress Protection	IP30 / IP54 (under special conditions)
Impact Protection	IK07
Flammability Degree	HB
Material	ABS
Color	white RAL 9003
Dimensions (H × W × D)	81 × 81 × 25 mm / short cover 116 × 81 × 25 mm / extended cover
Weight	0.08 kg

YouTube

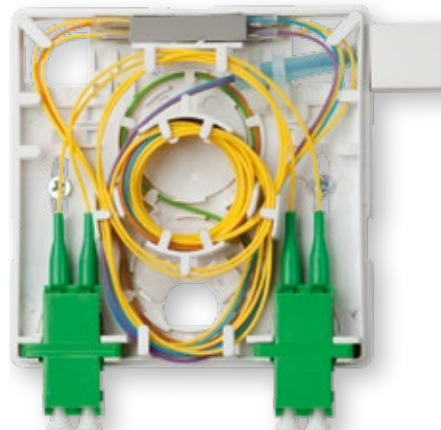
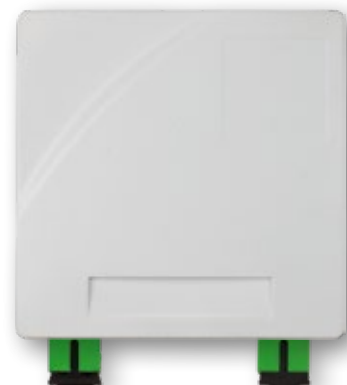
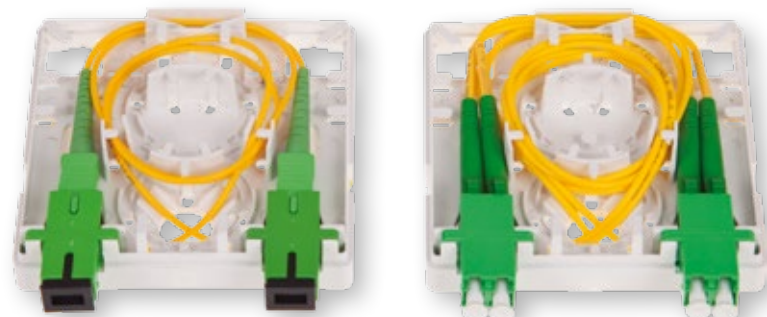

ORDERING CODES

		Position
85H4.00/0000F	ORM 1 (including a short and extended cover)	1
491797	Sealing for ORM 1 (IP 54)	2
491870	Laser Radiation Attention Sticker	3
491802	White Sticker (for description)	4
491816	Rubber Sealing (for a splice fixation)	5

▶ For other variants, please, contact our sales department.

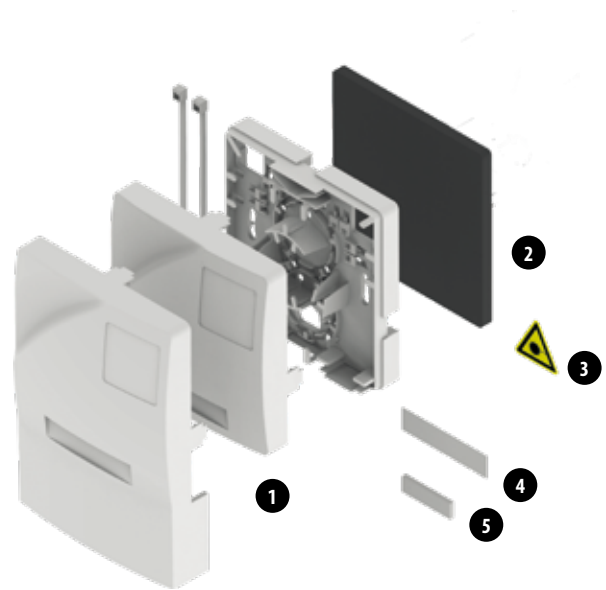

ORM 2

The ORM 2 is designed for the termination of 2 to 4 optical fibers in a customer terminal point or for interconnection of optical cables. It can be connected to a PC, different peripheral equipment or to another equipment via optical patchcords. The distributor is designed for indoor wall mounting. Inputs and outputs can vary by used panels.

- ▶ Capacity 4 optical connectors
- ▶ Connector holder SC simplex, SC duplex, ST, FC, E2000, LC
- ▶ Maximum capacity is 4 optical splices
- ▶ Direct fiber termination by a connector
- ▶ Easy assembly
- ▶ Wall-mounted
- ▶ Coverage degree IP 20
- ▶ Use for fibers G.652d, G.657

TECHNICAL SPECIFICATIONS

Ingress Protection	IP20
Impact Protection	IK04
Material	ABS
Color	light gray RAL 7035
Dimensions (H × W × D)	140 × 109 × 23 mm
Weight	0.1 kg

ORDERING CODES

8523.20/0000F	ORM 2
---------------	-------

▶ For other variants, please, contact our sales department.

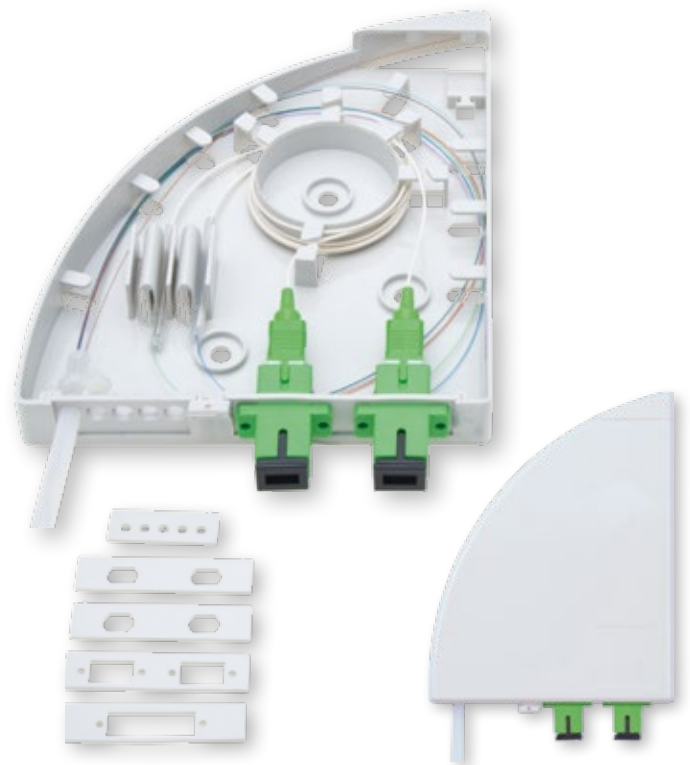

MTeH MINI

NEW **GPON READY**

The wall-mounted Fiber Optic Box MTeH MINI finds its application as a floor or a main fiber distribution box in apartment buildings / MDUs or single-family houses. It supports all cable applications (riser cables, buffered tubes, microtubes and ribbon cables), and it can be used for GPON networks with a pre-installed splitter. Its unique compact design and factory connectorized options help reduce assembly time and installation costs by up to 50 %. Key features include:

- ▶ The MTeH MINI enables termination of connectors and splicing of optical fibers.
- ▶ It can be pre-installed with adapters, pigtails or splitters from manufacturing.
- ▶ Compact size makes installation in small spaces possible.
- ▶ Two screw-lock doors – a larger one for a technician with professional skills, who works with splitters, splices and pigtails, and a smaller one for a technician without professional skills, who connects customer drop cables.
- ▶ Capacity of up to 14 splices
- ▶ Capacity of up to 12× SC / 24× LC connector (in case of a pre-connected cable)
- ▶ Capacity of up to 10× SC / 12× LC connector (in case of termination by splicing on pigtails)
- ▶ Integrated holder to support 2 splitters in the base of the box, possibility to place a holder for 12 splices
- ▶ PLC Splitter capability (1:2, 1:4, 1:8, 1:16 with LC connectors)
- ▶ Multiple cable or tube entry ports placed on all sides of the box increasing installation flexibility
- ▶ Support for vertical midspan (loop-through) cable
- ▶ Pre-moulded holes in the base for routing a cable through a wall
- ▶ Dedicated place for a company logo on the door of the box



Plug & Play Solution - Using Splitter

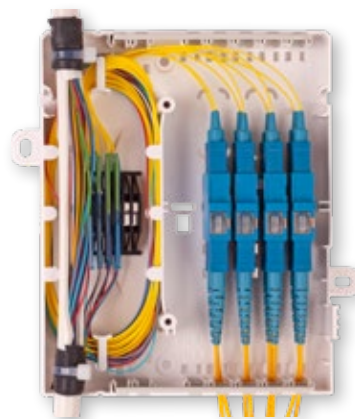

Riser Solution - Terminated on Pigtails



Riser Solution - Splicing Only

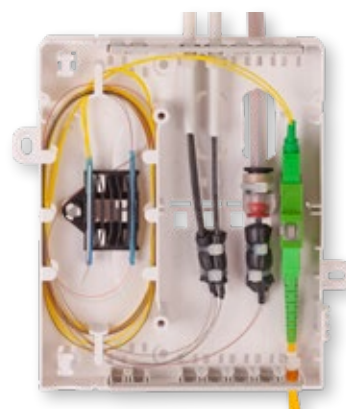

Combination of Usage

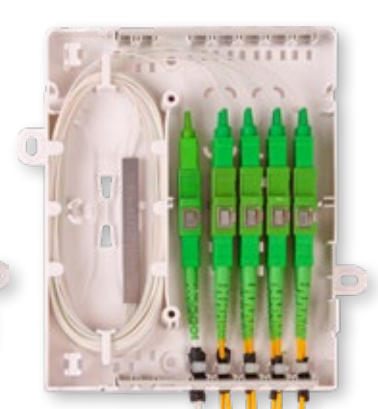

Plug & Play Solution - Using Splitter



TECHNICAL SPECIFICATIONS

Inputs / Outputs (quantity × range)	2× 1–14 mm, 16× 1–5 mm
Grommets (type and number of used grommets)	cable inlet
Ingress Protection	IP20
Impact Protection	IK08
Flammability Degree	V0
Material	PC / ABS
Color	white RAL 9003
Dimensions (H × W × D)	150 × 140 × 40 mm
Weight	0.2 kg

ORDERING CODES

85GR.00/0000F	Fiber Optic Box MTeH MINI
----------------------	---------------------------

▶ For other variants, please, contact our sales department.

MTeH EASY

GPON READY

The MTeH EASY is designed as a simple distribution box for indoor installation, especially for FTTH networks. MTeH EASY can be used for storage of pre-connectorized cable or blown cable which can be spliced after request of the customer. It could be used as a distribution point in a small building facility or as a floor box.

- ▶ Easy installation
- ▶ Wide portfolio of accessories
- ▶ Flat base with mounting holes
- ▶ Space for cable reserve before connecting customer
- ▶ Possibility to use the box for splicing or patching
- ▶ Two positions for adaptor plate
- ▶ Capacity up to 6x SC duplex, or 6x LC quad
- ▶ Graduated rubber grommet for cable Ø 3–10 mm (on each side)
- ▶ Breakable outputs on back side (connection through the wall directly to customer)
- ▶ Possibility to use loop-through cable
- ▶ Splice tray KM 4 (max. capacity 24 splices)
- ▶ 4x splice tray KM 3 (max. capacity 48 splices for fibres G.657)
- ▶ Possibility to place PLC splitter



Slack box



Base and adapters cover

You 



installation video 1



installation video 2

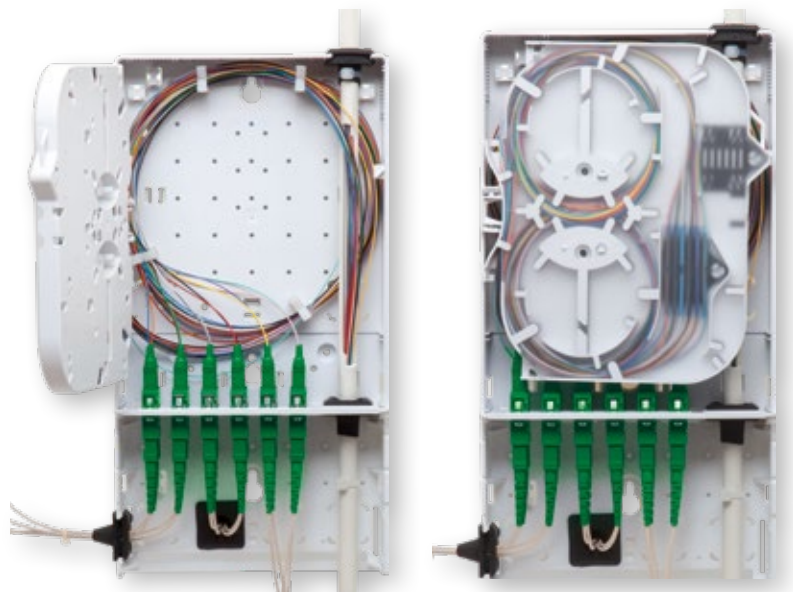

MTeH EASY 24S/12C with adapter cover

TECHNICAL SPECIFICATIONS

Inputs / Outputs (quantity × range)	1 × 3–10 mm
Grommets (type and number of used grommets)	1 × stepped grommet
Ingress Protection	IP20
Impact Protection	IK05
Flammability Degree	V0
Material	PC / ABS
Color	white RAL 9003
Dimensions (H × W × D)	205 × 157 × 60 mm
Weight	0.3 kg

ORDERING CODES

85AX.00/0000F	MTeH EASY – Slack Box
85AX.00/0002F	MTeH EASY 24S/12C
85AX.00/0003F	MTeH EASY 48S
85AX.15/0000F	Base and Adapters Cover

▶ For other variants, please, contact our sales department.

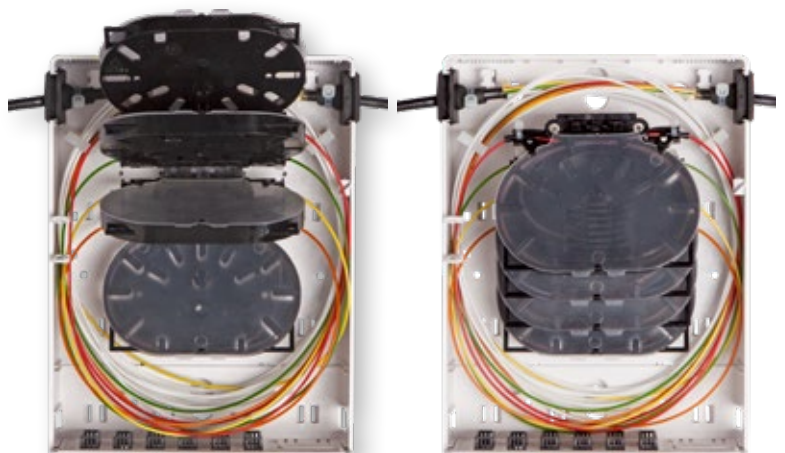

MTeH EASY 48S

MTeH UNI

GPON READY

The MTeH UNI is designed to be a very versatile optical distribution box, which can realize a wide range of configurations and interconnect the fibers in many ways. The wall box is suitable primarily as a distribution point in FTTH networks. The box includes two types of connector panel and two large splice trays KM 4.

- ▶ Capacity of up to 72 splices
- ▶ Capacity of up to 24× SC / 48× LC connector
- ▶ Easy installation
- ▶ Removable cover
- ▶ Cable reserves brackets
- ▶ Cable management
- ▶ Ability to splice in the bottom of the box
- ▶ Optional splicing or splitter boxes
- ▶ Possibility to use the box for splicing or patching
- ▶ Removable connector panel for 12× SC simplex, 12× SC duplex, 12× LCD or 12× LCQ
- ▶ Connector plate protected with a cover
- ▶ Gradual grommet ø 3–14 mm
- ▶ Input for 12 microducts up to ø 7 mm
- ▶ Preparation for the side entrance of Wall rails
- ▶ Optional wall through installation
- ▶ Mid-span access
- ▶ 2× splice tray KM 4 – total capacity 48 splices
- ▶ Maximum capacity 72 splices using splice section in the bottom of the box
- ▶ Duplex adapter point to connect PLC splitter
- ▶ Coverage degree IP 20



EXAMPLES OF INSTALLATION

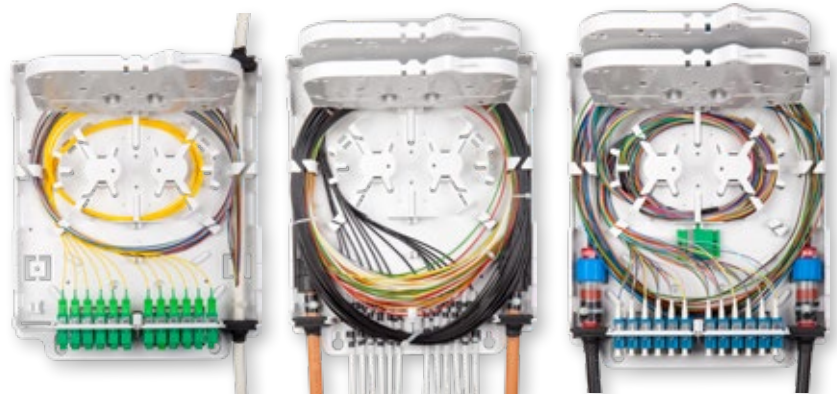

MTeH UNI 12× SC

MTeH UNI for splicing

MTeH UNI 48× LC

YouTube



installation video 1



installation video 2

TECHNICAL SPECIFICATIONS

Inputs / Outputs (quantity × range)	2× 3–14 mm
Grommets (type and number of used grommets)	2× stepped grommet
Ingress Protection	IP20
Impact Protection	IK07
Flammability Degree	V0
Material	PC / ABS
Color	white RAL 9003
Dimensions (H × W × D)	340 × 235 × 60 mm
Weight	0.9 kg



Example of PLC splitter installation



Example of extra splice tray holder

ORDERING CODES

85AV.00/0001F	MTeH UNI
85M9.16/0000	Splice Holder TS 12 (for heat shrink splices)
85M9.17/0000	Splice Holder K 12 (for crimp splices)
85SP.02/0000	Multi Cable Grommet (3-14 mm)

▶ For other variants, please, contact our sales department.

ORM 3 FA

GPON READY 5G READY

The ORM 3 FA is designed for facades. The in-line solution permits the passage of an outdoor riser cable that runs along the facade. The necessary fibers are pulled out of the cable, as is the case with conventional riser cables inside the building. For drop cables there is a separate grommet for up to 11 cable entries.

The box contains fiber management and a splice tray for 12 splices. If necessary, the box can be expanded by an extension frame and 2 extra trays to increase the splicing capacity to 36.

- ▶ Capacity of 12/24/36 optical splices
- ▶ Possibility to place a PLC splitter
- ▶ In-line solution for outdoor riser cable 2x Dividable rubber grommet (10–13 mm)
- ▶ Express port (2x 7–9 mm) and (9x 2–5 mm)
- ▶ Possible overcoating with a standard facade paint

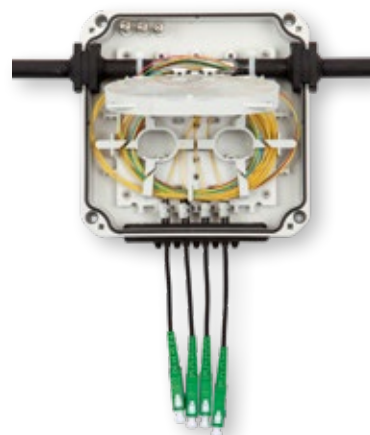

YouTube



Post Bracket for ORM 3

TECHNICAL SPECIFICATIONS

Inputs / Outputs (quantity × range)	2× 10–13 mm, 2× 3–9 mm, 9× 1.8–5 mm
Grommets (type and number of used grommets)	2× in-line grommet, 1× express port
Ingress Protection	IP54
Impact Protection	IK10
UV Resistance	yes
Flammability Degree	V0
Material	PC / ABS
Color	light gray RAL 7035
Dimensions (H × W × D)	136 × 136 × 46 mm
Weight	0.4 kg

ORDERING CODES

85BX.00/0100F	Outdoor Riser Cable Box ORM 3 FA
85BX.05/0000F	Outdoor Riser Cable Box ORM 3 FA (extension set)
85K3.11/BAL0F	Post Bracket for ORM 3

- ▶ For other variants, please, contact our sales department.

ORM 3 L/2

GPON READY 5G READY

TECHNICAL SPECIFICATIONS

Inputs / Outputs (quantity × range)	1× 3–6.5 mm, 4× 1–3 mm
Grommets (type and number of used grommets)	1× PG7, 2× rubber grommet
Ingress Protection	IP54
Impact Protection	IK10
UV Resistance	yes
Flammability Degree	V0
Material	PC / ABS
Color	light gray RAL 7035
Dimensions (H × W × D)	136 × 136 × 46 mm
Weight	0.4 kg

ORDERING CODES

85K3.40/0000F	ORM 3 L/2
85K3.11/BAL0F	Post Bracket for ORM 3

- ▶ For other variants, please, contact our sales department.



Post Bracket for ORM 3

ORM 3 L/4

GPON READY 5G READY

TECHNICAL SPECIFICATIONS

Inputs / Outputs (quantity × range)	1× 3–6.5 mm, 4× 1–3 mm
Grommets (type and number of used grommets)	1× PG7, 2× rubber grommet
Ingress Protection	IP54
Impact Protection	IK10
UV Resistance	yes
Flammability Degree	V0
Material	PC / ABS
Color	light gray RAL 7035
Dimensions (H × W × D)	136 × 136 × 46 mm
Weight	0.4 kg

ORDERING CODES

85K3.50/0000F	ORM 3 L/4
85K3.11/BAL0F	Post Bracket for ORM 3

► For other variants, please, contact our sales department.



Post Bracket for ORM 3

ORM 3 SL 12S

GPON READY 5G READY

TECHNICAL SPECIFICATIONS

Inputs / Outputs (quantity × range)	2× 3–9 mm, 9× 1.8–5 mm
Grommets (type and number of used grommets)	1× express port I.
Ingress Protection	IP54
Impact Protection	IK10
UV Resistance	yes
Flammability Degree	V0
Material	PC / ABS
Color	light gray RAL 7035
Dimensions (H × W × D)	136 × 136 × 46 mm
Weight	0.4 kg

ORDERING CODES

85K3.60/0000F	ORM 3 SL 12S
85K3.11/BAL0F	Post Bracket for ORM 3

► For other variants, please, contact our sales department.



Post Bracket for ORM 3

ORM 3 SH 24S

GPON READY 5G READY

TECHNICAL SPECIFICATIONS

Inputs / Outputs (quantity × range)	2× 3–9 mm, 9× 1.8–5 mm
Grommets (type and number of used grommets)	1× express port I.
Ingress Protection	IP54
Impact Protection	IK10
UV Resistance	yes
Flammability Degree	V0
Material	PC / ABS
Color	light gray RAL 7035
Dimensions (H × W × D)	136 × 136 × 64 mm
Weight	0.5 kg

ORDERING CODES

85K3.70/0000F	ORM 3 SH 24S
85K3.11/BAL0F	Post Bracket for ORM 3

► For other variants, please, contact our sales department.

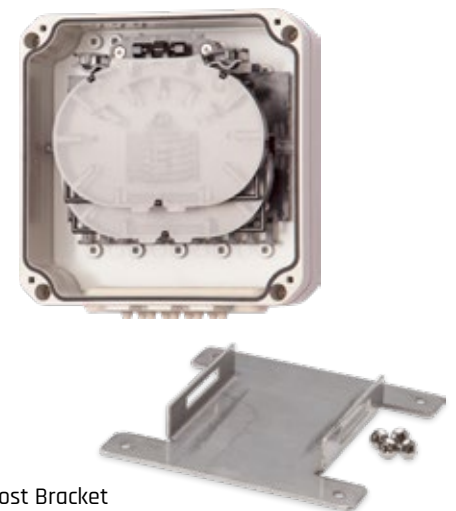

Post Bracket for ORM 3

ORM 5

BESTSELLER **GPON READY** **5G READY**

The Fiber Optic Box ORM 5 is a wall mounted closure designed for indoor / outdoor installation for the termination and distribution of optical fibers. The box is mainly suited for FTTH networks. It can be used both in suburban areas with a lower subscriber density (family houses, low apartment buildings or offices) or functions as a floor distribution box in multi-dwelling units (MDUs).

- ▶ Capacity of up to 12 splices
- ▶ Capacity of up to 4× SC / 8× LC connector
- ▶ Fiber Optic Tray KM 3 for up to 12 splices
- ▶ PLC Splitter capability (small format)
- ▶ Stepped grommet in the back wall of the box (ø 3–14 mm)
- ▶ Pre-fabricated access holes in the back wall of the box (grommet ø 5–9 mm)
- ▶ 4 splittable grommets, each of them for up to 2 patch cords
- ▶ Suitable and equipped for gas block installation (for a microtube with ø 5–14 mm)
- ▶ Optional pole bracket
- ▶ Optional lockable lid
- ▶ Hinged removable lid to facilitate easy access
- ▶ Simple installation

TECHNICAL SPECIFICATIONS

Inputs / Outputs (quantity × range)	4 × 3–14 mm / 8 × 1–3 mm, 1 × 3–14 mm
Grommets (type and number of used grommets)	4 × stepped grommet / 4 × splittable grommet, 1 × stepped grommet
Ingress Protection	IP55
Impact Protection	IK10
UV Resistance	yes
Temperature Range	–40 °C / +70 °C
Material	PC / ABS
Color	light gray RAL 7035
Dimensions (H × W × D)	235 × 156 × 45 mm
Weight	0.5 kg

ORDERING CODES

85BV.01/0000F	Lock for ORM 5
85SP.00/0000F	Fiber Optic Box ORM 5
85E0.97/00R5F	Pole Bracket for ORM 5

- ▶ For other variants, please, contact our sales department.



ORM 5 with Folded Tray, Microtube and Gasblock

ORM 5 with Tilted Tray (4× SC)



Robust Lid of ORM 5



Pole Bracket for ORM 5

MDB XS

- NEW
- GPON READY
- 5G READY
- FiberRoad
- SFMS

The Fiber Optic Box MDB XS, designed for various fiber organizers inside, can be configured to address a wide range of fiber optic splice and/or connectivity applications for PON, GPON and 5G networks. The MDB XS provides the ideal splicing solution for multi dwelling unit fiber distribution points or outdoor pole mounted splice applications.

- ▶ Capacity of up to 48 splices
- ▶ Capacity of up to 16x SC / 32x LC connector (for boxes with organizer B)
- ▶ Multiple cable or tube entry ports on all sides of the box to increase installation flexibility
- ▶ Top output – PG grommet for using outdoors, Grommets System for using indoors
- ▶ Support for various fiber organizers
- ▶ Fiber Optic Tray KM 6 for up to 24 splices (2 pcs max., organizer A)
- ▶ Holder for 6 pcs of adapters – Simplex, Duplex or LC Quad (for boxes with organizer A)
- ▶ Optional placing of PLC Splitters in the management (outside a tray)
- ▶ Removable internal fiber management chassis to enable maximum access
- ▶ Support for ribbon fibers
- ▶ Support for midspan (loop-through) cable deployments (via an express port)
- ▶ Grommets system for cables with diameters 1.8–13 mm
- ▶ Increased durability, impact protection and water / dust ingress resistance (IP65, IK10)
- ▶ Integrated pole bracket
- ▶ Suitable for all types of networks

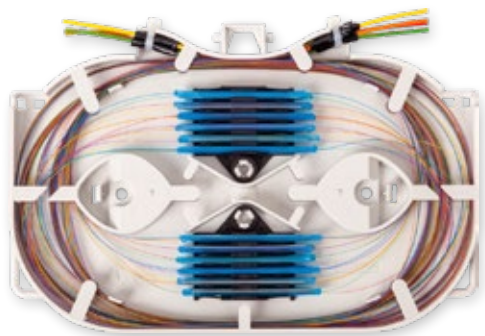

KM 6
 • For splicing
 • Up to 24 splices



SFMS SYSTEM
 • For splicing
 • Up to 12 splices
 • Only for fibers ø 0.25 mm

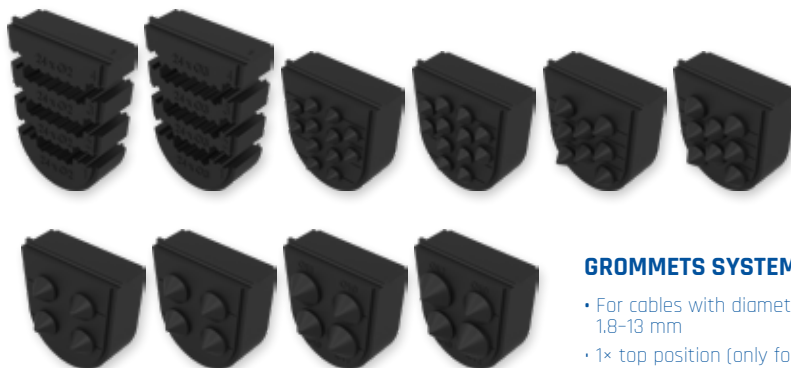

GROMMETS SYSTEM
 • For cables with diameters 1.8–13 mm
 • 1x top position (only for using indoors)
 • 2x bottom position

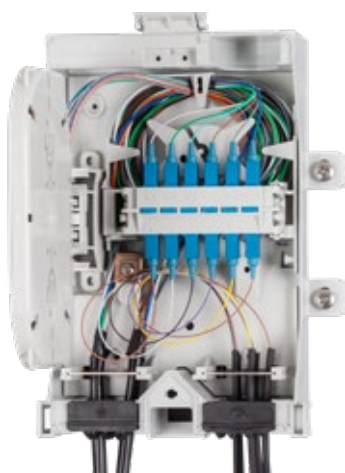

MDB XS-EC N-A-DP
PATCHING: 6× SC CONNECTOR



MDB XS-EC N-C-AAAA
SPLICING: 24 SPLICES + SPLITTER



MDB XS-EA N-B-D
PATCHING: 16× SC CONNECTOR



**Cable Reserve Holder
for Pole**



**Integrated pole
bracket**

TECHNICAL SPECIFICATIONS

Inputs / Outputs (quantity × range)	For using outdoors: 2× 1.8–13 mm
	1× 10–14 mm or optional insert
Grommets (type and number of used grommets)	For using indoors: 3× 1.8–13 mm (follow the Configurator – Section 1 – Grommets Selection)
	For using outdoors: Grommets System – 2 pcs PG 16 – 1 pc
Ingress Protection	IP65
Impact Protection	IK10
Flammability Degree	V0
Material	PC / ASA
Color	Light gray RAL 7035
Dimensions (H × W × D)	252 × 150 × 85 mm
Weight	1 kg

ORDERING CODES

On request	Custom Configuration
Follow the Configurator (Section 1)	Grommets Kit Separately
Follow the Configurator (Section 2)	Box with Organizer Separately
Follow the Configurator (Section 3)	Tray Kit Separately
85U8.15/000X	Cable Reserve Holder for Pole (for MDB XS)

► For other variants, please, contact our sales department.

Section 0
Box

Section 1
Grommets Selection

Section 2
Organizer Selection

MDB XS

XX X

X

A

B

C

bottom top
A-K – Only for using indoors
P – For using outdoors



Select 3 options as below:		
A		24× 1.8–2.2 mm (already cut) 85C3.60/000X
B		24× 2.2–3.0 mm (already cut) 85C3.61/000X
C		12× 3.6–4.6 mm (can be cut) 85C3.71/000X
D		12× 4.6–5.6 mm (can be cut) 85C3.62/000X
E		8× 5.6–6.6 mm (can be cut) 85C3.69/000X
F		8× 6.6–7.6 mm (can be cut) 85C3.63/000X
G		4× 7.6–8.6 mm (can be cut) 85C3.68/000X
H		4× 8.6–9.6 mm (can be cut) 85C3.64/000X
J		2× 9.6–10.6 mm 2× 11.6–13.0 mm (can be cut) 85C3.65/000X
K		2× 9.6–10.6 mm 2× 10.6–11.6 mm (can be cut) 85C3.66/000X
P		PG 16 Grommet – only top inputs for using outdoors On request
N	NONE	The position remains empty





Select 1 option as below:	
A	<p>Patching and splicing</p> <p>Use with adapters Ability to combine KM 6 with the adapter holder Capacity of up to 48 splices (without the adapter holder) Capacity of up to 12× SC / 24× LC connector 85U8.17/000X</p>
B	<p>Patching, covered splicing section</p> <p>Use with adapters Capacity of up to 24 splices (covered splicing section) Capacity of up to 16× SC / 32× LC connector 85U8.16/000X</p>
C	<p>Only splicing, SFMS Trays</p> <p>Only splicing SFMS Trays For SC Short, SE Short Capacity of up to 24 splices 85U8.18/000X</p>



Section 3 Tray Type Selection





XX

X

XXXX

Select 2 options as below (only for management „A“):		
D		KM 6 for heatshrink 85C3.83/000X
E		KM 6 for ribbon 85C3.84/000X
F		KM 6 for crimp 85C3.85/000X
P		Adapter Panel MDB XS Capacity of up to 6× SC / 12× LC connector (SC simplex / LC duplex) 85U8.14/000X
N	NONE	The position remains empty

Select 1 option as below (only for management „B“):		
D		KM 6 for heatshrink 85C3.83/000X
E		KM 6 for ribbon 85C3.84/000X
F		KM 6 for crimp 85C3.85/000X
N	NONE	The position remains empty

Select up to 4 options as below (only for management „C“):		
A		SC Short, 6F, for heatshrink 80811933
B		SC Short, 12F, for crimp 50161402
C2		SE Short, 12F, for heatshrink 80811935
D2		SE Short, 4× ribbon or 4× splitter, for ribbon 80812916
N	NONE	The position remains empty

TRAYS COMPATIBLE WITH
THE FIBEROAD™ SYSTEM

SFMS TRAYS

Examples of creating a name:

MDB XS-EA N-A-DP

MDB XS-FA A-B-D

MDB XS-EA N-C-AAAA

Section 0

Section 1

Section 3

MDB S

NEW GPON READY 5G READY FiberRoad SFMS

The Fiber Optic Box MDB S is a durable fiber optic box, designed for various fiber organizers inside. The box can be configured to address a wide range of fiber optic splice and/or connectivity applications for PON, GPON and 5G networks. The engineered design provides IP65 protection from water / dust ingress and IK10 impact resistance to keep your critical network connections safe inside. The MDB S provides the ideal splicing solution for multi dwelling unit fiber distribution points or outdoor pole mounted splice applications.

- ▶ Capacity of up to 96 splices
- ▶ Capacity of up to 24x SC / 48x LC connector
- ▶ Multiple cable or tube entry ports on all sides of the box to increase installation flexibility
- ▶ Top outputs – PG grommets for using outdoors, Grommets System for using indoors
- ▶ Support for various fiber organizers
- ▶ Fiber Optic Tray KM 6 for up to 24 splices (4 pcs max.)
- ▶ Holder for 12 pcs of adapters (Simplex, Duplex or LC Quad)
- ▶ Optional placing of PLC Splitters in the management (outside a tray)
- ▶ Removable internal fiber management chassis to enable maximum access
- ▶ Support for ribbon fibers
- ▶ Support for midspan (loop-through) cable deployments (via an express port)
- ▶ Grommets system for cables with diameters 1.8–13 mm
- ▶ Increased durability, impact protection and water / dust ingress resistance (IP65, IK10)
- ▶ Integrated pole bracket
- ▶ Suitable for all types of networks

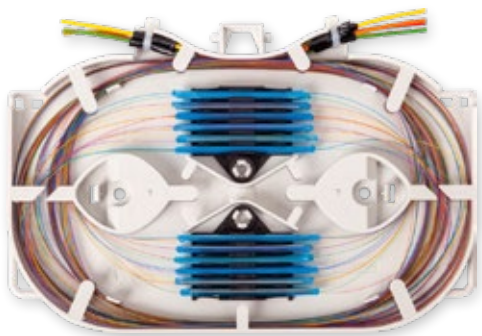

KM 6

- For splicing
- Up to 24 splices

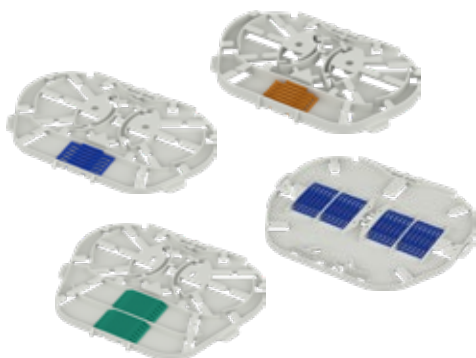

SFMS SYSTEM

- For splicing
- Up to 12 splices
- Only for fibers ø 0.25 mm



GROMMETS SYSTEM

- For cables with diameters 1.8–13 mm
- 2x top position (only for using indoors)
- 3x bottom position

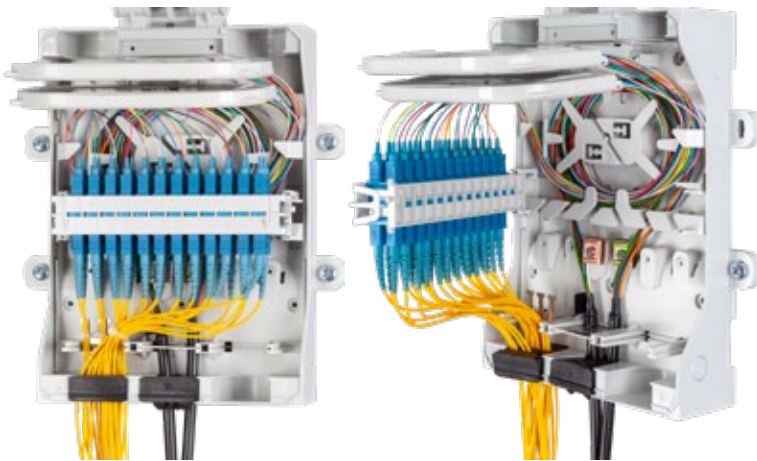

MDB S-AFN NN-A-DDP2
PATCHING: 24× SC CONNECTOR



MDB S-AEN NN-B-DD
PATCHING: 48× LC CONNECTOR

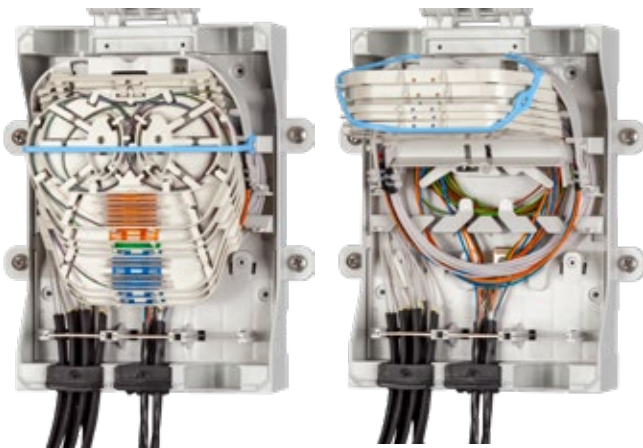

MDB S-CEN NN-C-EEEAC2C2
SPLICING: 96 SPLICES



Cable Reserve Holder for Pole (for MDB S)

Integrated pole bracket



TECHNICAL SPECIFICATIONS

Inputs / Outputs (quantity × range)	For using outdoors:
	3× 1.8–13 mm 2× 10–14 mm or optional insert
Grommets (type and number of used grommets)	For using indoors:
	5× 1.8–13 mm (follow the Configurator – Section 1 – Grommets Selection)
Ingress Protection	For using outdoors:
	IP65
Impact Protection	For using indoors:
	Grommets System – 3 pcs PG 16 – 2 pcs
Flammability Degree	For using indoors:
	Grommets System – 5 pcs
Material	PC / ASA
Color	Light gray RAL 7035
Dimensions (H × W × D)	295 × 187 × 106 mm
Weight	2 kg

ORDERING CODES

On request	Custom Configuration
Follow the Configurator (Section 1)	Grommets Kit Separately
Follow the Configurator (Section 2)	Box with Organizer Separately
Follow the Configurator (Section 3)	Tray Kit Separately
85TG.24/000XF	Cable Reserve Holder for Pole (for MDB S)

► For other variants, please, contact our sales department.

Section 0
Box

Section 1
Grommets Selection

Section 2
Organizer Selection

MDB S

XXX XX

X

A
B
C

bottom top
A-K – Only for using indoors
P – For using outdoors



Select 5 options as below:		
A		24× 1.8–2.2 mm (already cut) 85C3.60/000X
B		24× 2.2–3.0 mm (already cut) 85C3.61/000X
C		12× 3.6–4.6 mm (can be cut) 85C3.71/000X
D		12× 4.6–5.6 mm (can be cut) 85C3.62/000X
E		8× 5.6–6.6 mm (can be cut) 85C3.69/000X
F		8× 6.6–7.6 mm (can be cut) 85C3.63/000X
G		4× 7.6–8.6 mm (can be cut) 85C3.68/000X
H		4× 8.6–9.6 mm (can be cut) 85C3.64/000X
J		2× 9.6–10.6 mm 2× 11.6–13.0 mm (can be cut) 85C3.65/000X
K		2× 9.6–10.6 mm 2× 10.6–11.6 mm (can be cut) 85C3.66/000X
P		PG 16 Grommet – only top inputs for using outdoors On request
N	NONE	The position remains empty





Select 1 option as below:		
A	<p>Patching and splicing</p>	<p>Use with adapters Ability to combine KM 6 with the adapter holder Capacity of up to 96 splices (without the adapter holder) Capacity of up to 24× SC / 48× LC connector 85TG.20/000X</p>
B	<p>Patching, covered splicing section</p>	<p>Use with adapters Capacity of up to 48 splices (covered splicing section) Capacity of up to 24× SC / 48× LC connector 85TG.21/000X</p>
C	<p>Only splicing, SFMS Trays</p>	<p>Only splicing SFMS Trays Capacity of up to 96 splices 85TG.22/000X</p>



Section 3 Tray Type Selection









XXXX

XX

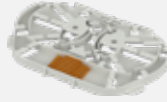
XXXX XXXX

Select up to 4 options as below (only for management „A“):		
D		KM 6 for heatshrink 85C3.83/000X
E		KM 6 for ribbon 85C3.84/000X
F		KM 6 for crimp 85C3.85/000X
P		Adapter Panel MDB S Capacity of up to 12× SC / 24× LC connector (SC simplex / LC duplex) 85TG.23/000X
P2		Adapter Panel MDB S Capacity of up to 24× SC / 48× LC connector (SC duplex / LC quad) 85TG.23/000X
N	NONE	The position remains empty

Select 2 options as below (only for management „B“):		
D		KM 6 for heatshrink 85C3.83/000X
E		KM 6 for ribbon 85C3.84/000X
F		KM 6 for crimp 85C3.85/000X
N	NONE	The position remains empty

Select up to 8 options as below (only for management „C“):		
A		SC Short, 6F, for heatshrink 80811933
B		SC Short, 12F, for crimp 50161402
C2		SE Short, 12F, for heatshrink 80811935
D2		SE Short, 4× ribbon or 4× splitter, for ribbon 80812916
E		SC Long, 12F, for heatshrink 80812456
F		SC Long, 24F, for crimp 85100030
G		SC Long, 24F + splitter, for heatshrink 50161971
H		SC Long, 24F + splitter, for crimp 85100031
N	NONE	The position remains empty

TRAYS COMPATIBLE WITH
THE FIBEROAD™ SYSTEM

SFMS TRAYS

Examples of creating a name:

MDB S-AAG NN-A-DDP2

MDB S-ECC NN-B-DD

MDB S-JAA NN-C-C2C2 C2C2

Section 0

Section 1

Section 2

Section 3

MDB M

NEW **GPON READY** **5G READY** **FiberRoad**

The Fiber Optic Box MDB M is a durable fiber optic box, designed with the highly flexible FiberRoad™ System inside. The box can be configured to address a wide range of fiber optic splice and/or connectivity applications for PON, GPON and 5G networks. The engineered design provides IP65 protection from water / dust ingress and IK10 impact resistance to keep your critical network connections safe inside. The MDB M provides the ideal splicing solution for multi dwelling unit fiber distribution points or outdoor pole mounted splice applications.

- ▶ Capacity of up to 144 splices
- ▶ Capacity of up to 48× SC / 96× LC connector
- ▶ Multiple cable or tube entry ports on all sides of the box to increase installation flexibility
- ▶ Top outputs – PG grommets for using outdoors, Grommets System for using indoors
- ▶ Ability to mix & match the Fiber Optic Trays KM 4, KM 5, KM 6, KM 7, KM 9
- ▶ KM 4 and KM 6 for up to 24 splices (6 pcs max.)
- ▶ KM 5 for up to 12× SC / 24× LC connector (4 pcs max.)
- ▶ KM 7 for up to 8× SC / 16× LC connector (for GPON, 4 pcs max.)
- ▶ KM 9 for up to 12 splices (12 pcs max.)
- ▶ Scalable through gradual adding of trays
- ▶ Optional placing of PLC Splitters in the management (outside a tray)
- ▶ Up to 2 PLC Splitters ABS together with 4× KM 7
- ▶ Hingeable (or detachable) splicing (or patching) section
- ▶ FiberRoad™ System compatible
- ▶ Removable internal fiber management chassis to enable maximum access
- ▶ Support for ribbon fibers
- ▶ Support for midspan (loop-through) cable deployments (via an express port)
- ▶ Grommets system for cables with diameters 1.8–13 mm
- ▶ Increased durability, impact protection and water / dust ingress resistance (IP65, IK10)
- ▶ Significant space for patch cords and cables reserves
- ▶ Optional pole bracket
- ▶ Suitable for all types of networks



MDB M



KM 4

- For splicing
- Up to 24 splices

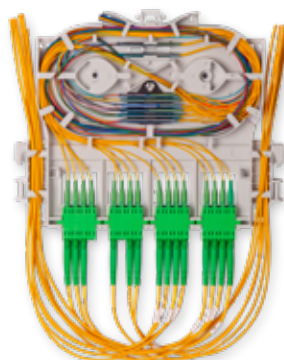

KM 7

- For adapters
- Up to 8× SC / 16× LC connector
- Up to 16 splices



KM 9

- For splicing
- Up to 12 splices



KM 5

- For adapters
- Up to 12× SC / 24× LC connector
- Up to 24 splices



KM 6

- For splicing
- Up to 24 splices

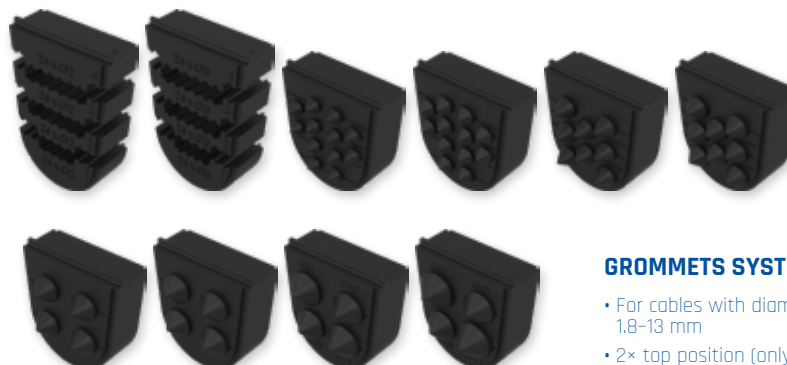

GROMMETS SYSTEM

- For cables with diameters 1.8–13 mm
- 2× top position (only for using indoors)
- 5× bottom position

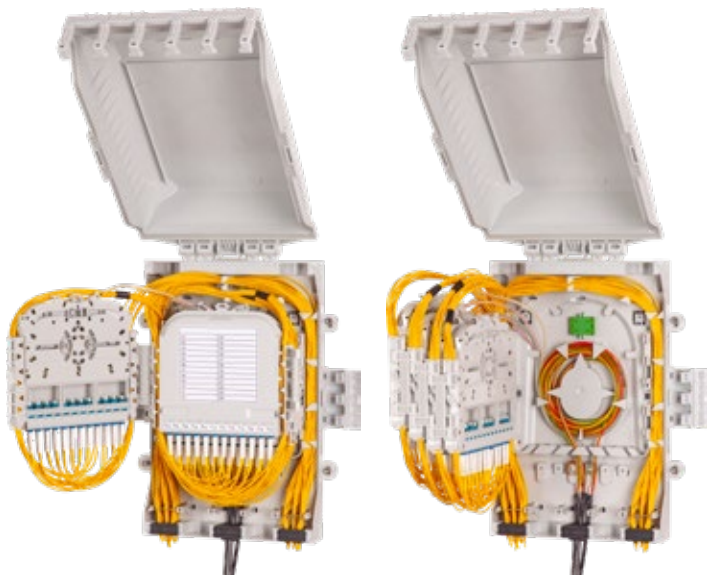

MDB M-LLHNN NN-A-KAKAKAKA
PATCHING: 96× LC CONNECTOR

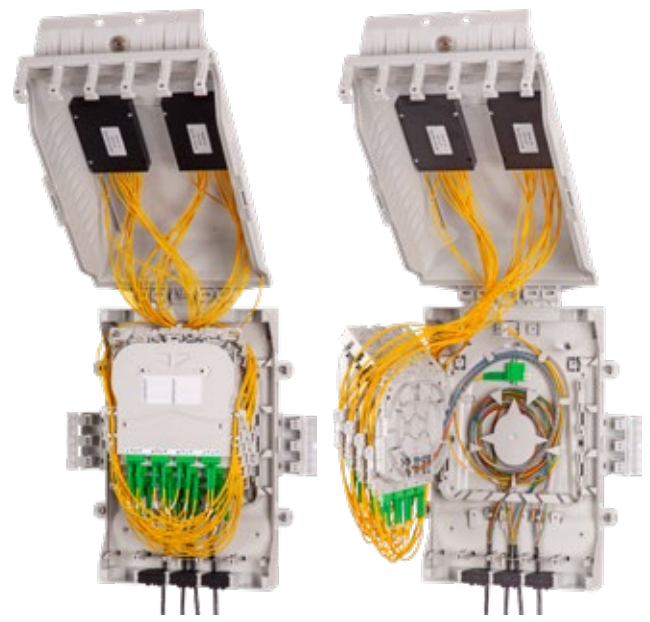

MDB M-HHHNN NN-B-GGGG
PATCHING: 64× LC CONNECTOR + PLC SPLITTERS ABS



MDB M-LLHNN NN-C-AAAAA
SPLICING: 144 SPLICES



Cable Reserve Holder for Pole (for MDB M)



Pole Bracket

TECHNICAL SPECIFICATIONS

Inputs / Outputs (quantity × range)	For using outdoors: 5× 1.8–13 mm 2× 10–14 mm or optional insert
	For using indoors: 7× 1.8–13 mm (follow the Configurator – Section 1 – Grommets Selection)
Grommets (type and number of used grommets)	For using outdoors: Grommets System – 5 pcs PG 16 – 2 pcs
	For using indoors: Grommets System – 7 pcs
Ingress Protection	IP65
Impact Protection	IK10
Flammability Degree	V0
Material	PC / ASA
Color	Light gray RAL 7035
Dimensions (H × W × D)	427 × 290 × 132 mm
Weight	2 kg

ORDERING CODES

On request	Custom Configuration
Follow the Configurator (Section 1)	Grommets Kit Separately
Follow the Configurator (Section 2)	Box with Organizer Separately
Follow the Configurator (Section 3)	Tray Kit Separately
85E0.97/0000F	Pole Bracket
85DZ.80/000XF	Cable Reserve Holder for Pole (for MDB M)

► For other variants, please, contact our sales department.

Section 0
Box

Section 1
Grommets Selection

Section 2
Organizer Selection

MDB M

XXXXX XX

X

bottom

top

A-K – Only for using indoors

P – For using outdoors

A
B
C
D



Select 7 options as below:

A		24× 1.8–2.2 mm (already cut) 85C3.60/000X
B		24× 2.2–3.0 mm (already cut) 85C3.61/000X
C		12× 3.6–4.6 mm (can be cut) 85C3.71/000X
D		12× 4.6–5.6 mm (can be cut) 85C3.62/000X
E		8× 5.6–6.6 mm (can be cut) 85C3.69/000X
F		8× 6.6–7.6 mm (can be cut) 85C3.63/000X
G		4× 7.6–8.6 mm (can be cut) 85C3.68/000X
H		4× 8.6–9.6 mm (can be cut) 85C3.64/000X
J		2× 9.6–10.6 mm 2× 11.6–13.0 mm (can be cut) 85C3.65/000X
K		2× 9.6–10.6 mm 2× 10.6–11.6 mm (can be cut) 85C3.66/000X
P		PG 16 Grommet – only top inputs for using outdoors On request
N	NONE	The position remains empty

Select 1 option as below:

A	Patching 	Use with adapters For KM 5 Capacity of up to 96 splices Capacity of up to 48× SC / 96× LC connector 85C3.91/000X
B	Patching and splicing 	Use with adapters Ability to mix & match KM 4, KM 5, KM 6, KM 7 Capacity of up to 96 splices Capacity of up to 32× SC / 64× LC connector Optional PLC Splitters ABS 85C3.92/000X
C	Only splicing 	Only splicing For KM 4 and KM 6 Capacity of up to 144 splices 85C3.93/000X
D	Only splicing 	Only splicing For KM 8 and KM 9 Capacity of up to 144 splices 85C3.94/000X

YouTube



Section 3 Tray Type Selection

XXXX XXXX

XXXX

XXXX XX

XXXXXX XXXXXX

Select up to 8 options as below (only for management „A“):

KA		KM 5 for heatshrink SC / LC connectors 85C3.76/000X
KB		KM 5 for ribbon SC / LC connectors 85C3.77/000X
KC		KM 5 for crimp SC / LC connectors 85C3.78/000X
N	NONE	The position remains empty

Select up to 4 options as below (only for management „B“):

A		KM 4 for heatshrink 85C3.79/000X
B		KM 4 for ribbon 85C3.81/000X
C		KM 4 for crimp 85C3.82/000X
D		KM 6 for heatshrink 85C3.83/000X
E		KM 6 for ribbon 85C3.84/000X
F		KM 6 for crimp 85C3.85/000X
G		KM 7 for heatshrink SC / LC connectors 85C3.86/000X
H		KM 7 for ribbon SC / LC connectors 85C3.87/000X
J		KM 7 for crimp SC / LC connectors 85C3.88/000X
KA		KM 5 for heatshrink SC / LC connectors 85C3.76/000X
KB		KM 5 for ribbon SC / LC connectors 85C3.77/000X
KC		KM 5 for crimp SC / LC connectors 85C3.78/000X
N	NONE	The position remains empty

Select 6 options as below (only for management „C“):

A		KM 4 for heatshrink 85C3.79/000X
B		KM 4 for ribbon 85C3.81/000X
C		KM 4 for crimp 85C3.82/000X
D		KM 6 for heatshrink 85C3.83/000X
E		KM 6 for ribbon 85C3.84/000X
F		KM 6 for crimp 85C3.85/000X
N	NONE	The position remains empty

Select 12 options as below (only for management „D“):

L		KM 9 for heatshrink and crimp 85C3.90/000X
N	NONE	The position remains empty

Examples of creating a name:

MDB M-AJJNN NN-A-KAKA KAKA

MDB M-BBKkk NN-B-AAGG

MDB M-BBGGG NN-C-AAAA AA

MDB M-BBKkk NN-D-LLLLLL LLNNNN

Section 0

Section 1

Section 2

Section 3

MAB

NEW **GPON READY** **5G READY**

The Fiber Optic Box MAB is used to store up to 60 splices or to terminate up to 12 fibers with SC/LC connectors in a flip tray splice system. It provides the ability to connect customers in three ways (pre-connectorized drop cables, splicing or splicing in a subscriber tray with six separate sections). The box can be equipped with an internal cover to protect the splicing section. An integrated pole mount is included, making it suitable as an access point for overhead GPON or 5G networks.

- ▶ Capacity of up to 60 splices
- ▶ Capacity of up to 12× SC connector (24 splices only)
- ▶ Capacity of up to 12× LC connector (only 48 splices without internal cover)
- ▶ Fiber management with flip tray splice system
- ▶ Optional placing of PLC Splitters outside a tray (2× small format of 4 × 4 × 40 mm)
- ▶ One optional subscriber tray with six separate sections
- ▶ Optional internal cover to protect the main network fibers
- ▶ 4× 1.6–14 mm input
- ▶ 12× 1.6–10 mm input
- ▶ Support for midspan (loop-through) cable
- ▶ Integrated pole bracket
- ▶ Optional Cable Reserve Holder
- ▶ Ability to secure the lid with a screw
- ▶ Suitable for overhead networks
- ▶ Suitable for GPON and 5G networks
- ▶ For G.657A fibers



MAB 60S (60 splices)



TECHNICAL SPECIFICATIONS

Inputs / Outputs (quantity × range)	4× 1.6–14 mm, 12× 1.6–10 mm
Grommets (type and number of used grommets)	Multi-Hole Grommet
Ingress Protection	IP54
Impact Protection	IK08
Material	PC / ABS
Color	light gray RAL 7035
Dimensions (H × W × D)	297.5 × 239 × 73 mm
Weight	1 kg

ORDERING CODES

85TZ.30/000XF	MAB 60S
85TZ.31/000XF	MAB 12/12 Trays Cover
85TZ.29/000XF	Cable Reserve Holder for MAB
496352	Subscriber Tray with Six Separate Sections
85TZ.18/000X	Fiber Optic Tray MAB

- ▶ For other variants, please, contact our sales department.



MAB without Trays



MAB 12/12 Trays Cover
(6x LC duplex and internal cover)



MAB 60S (60 splices)



MAB 12/12 Trays Cover
(6x SC duplex and internal cover)



MAB 12/12 Trays Cover (6x SC duplex
and hinged internal cover)



MAB with a Subscriber Tray



Subscriber Tray with
Six Separate Sections



Fiber Optic Tray MAB











Cable Reserve Holder for MAB

FTTA 12/24/48

NEW **5G READY**

The Fiber Optic Box FTTA 12/24/48 is used to connect 6/12/24 remote radio heads. The engineered design provides IP65 protection from water / dust ingress and IK10 impact resistance to keep your critical network connections safe inside.

- ▶ Capacity of up to 12× LC connector (FTTA 12)
- ▶ Capacity of up to 24× LC connector (FTTA 24)
- ▶ Capacity of up to 48× LC connector (FTTA 48)
- ▶ Support of up to 6/12/24 remote radio heads
- ▶ Grommets system for cables with diameters 1.8–13 mm
- ▶ Grommets can be cut (compatible with connectors)
- ▶ Increased durability, impact protection and water / dust ingress resistance (IP65, IK10)
- ▶ Integrated pole bracket (only FTTA 12/24)
- ▶ Brackets for fixing cables inside the box
- ▶ Option to fix cables outside the box (on request)

GROMMETS SYSTEM		
C		12× 3.6–4.6 mm (can be cut)
D		12× 4.6–5.6 mm (can be cut)
E		8× 5.6–6.6 mm (can be cut)
F		8× 6.6–7.6 mm (can be cut)
G		4× 7.6–8.6 mm (can be cut)
H		4× 8.6–9.6 mm (can be cut)
J		2× 9.6–10.6 mm 2× 11.6–13.0 mm (can be cut)
K		2× 9.6–10.6 mm 2× 10.6–11.6 mm (can be cut)

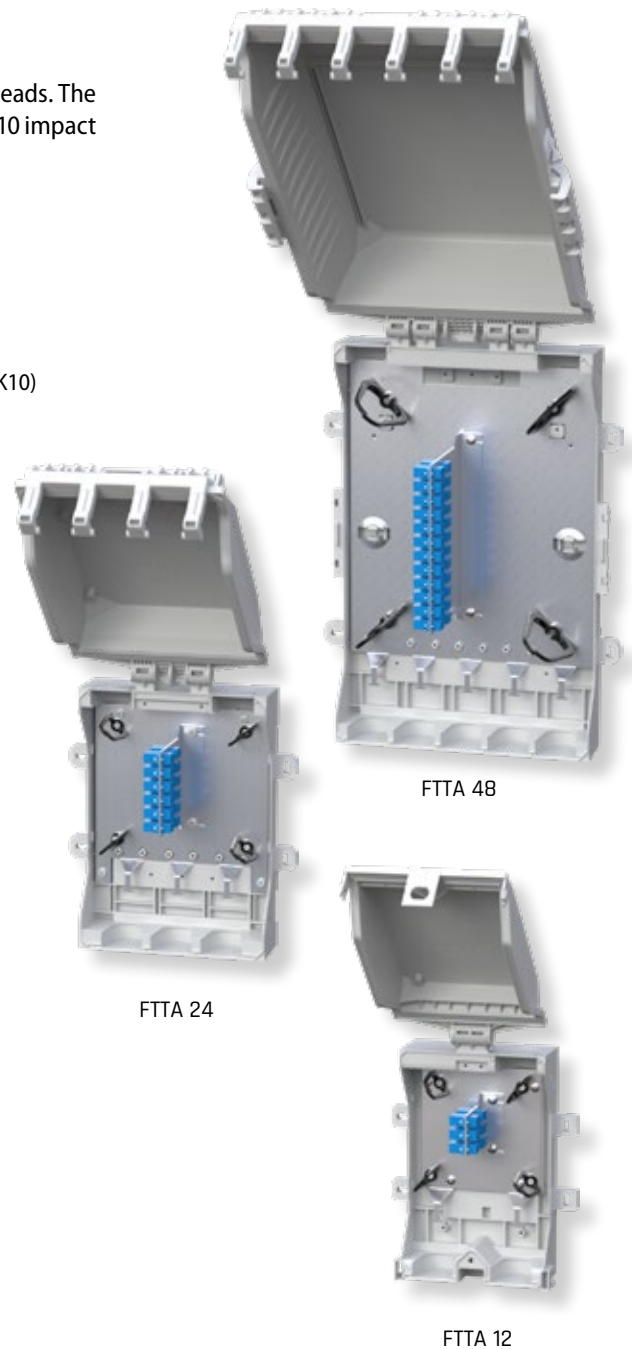

TECHNICAL SPECIFICATIONS

Inputs / Outputs (quantity × range)	5 / 6 / 6× 8–16 mm
Grommets (type and number of used grommets)	5 / 6 / 6× PG16
Ingress Protection	IP65
Impact Protection	IK10
Material	PC / ABS
Color	Light gray RAL 7035
Dimensions (H × W × D)	400 × 300 × 170 mm / 500 × 400 × 170 mm / 600 × 400 × 200 mm
Weight	4 / 5.5 / 6.5 kg

ORDERING CODES

On request	FTTA 12
On request	FTTA 24
On request	FTTA 48
85E0.97/0000F	Pole Bracket (only for FTTA 48)
85BV.49/0145F	Pole Clamp max. ø 90
85BV.49/0370F	Pole Clamp max. ø 145
85BV.49/0570F	Pole Clamp max. ø 370

▶ For other variants, please, contact our sales department.

MDB FA 144/192/288S

GPON READY
5G READY
FibeRoad

The optical distribution box MDB FA 144/192/288S is designed for the placement of 144/192/288 optical splices indoors and outdoor. A pole holder can be attached. A very suitable solution for spliced GPON networks.

- ▶ Maximum capacity of 144/192/288 splices
- ▶ Cable rings
- ▶ Placement of a large slack inside the cable management
- ▶ Removable splicing part
- ▶ FibeRoad™ System
- ▶ Modular capacity increase
- ▶ Possibility of placing PLC splitters inside the management (outside the trays)
- ▶ KM 4 trays for 24 splices
- ▶ Possibility of using ribbon fibers



MDB FA 144S



MDB FA 288S

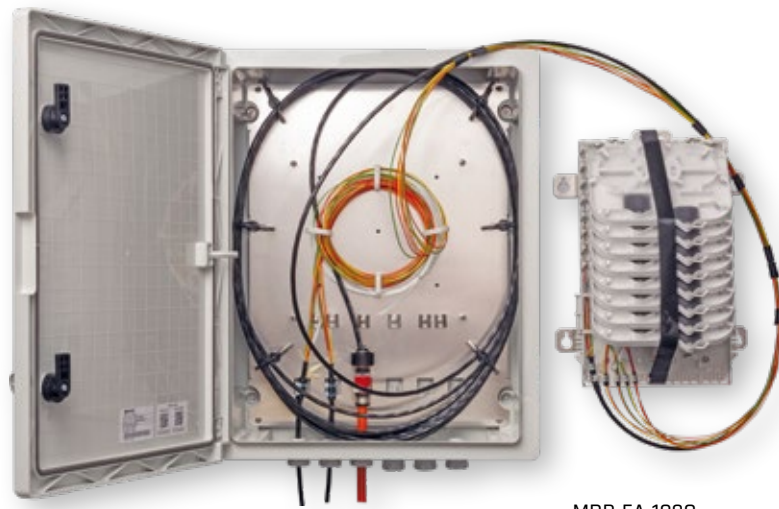

MDB FA 192S

TECHNICAL SPECIFICATIONS

Inputs / Outputs (quantity × range)	5 / 6 / 6 × 8–16 mm
Grommets (type and number of used grommets)	5 / 6 / 6 × PG16
Ingress Protection	IP65
Impact Protection	IK08
Material	ABS
Color	light gray RAL 7035
Dimensions (H × W × D)	400 × 300 × 170 mm / 500 × 400 × 170 mm / 600 × 400 × 200 mm
Weight	4 / 5.5 / 6.5 kg

ORDERING CODES

85TA.00/0000F	MDB FA 144S
85TA.10/0000F	MDB FA 192S
85TA.20/0000F	MDB FA 288S
496041	Key Lock (set of 2 pcs needed)
85C3.79/000X	KM 4 Kit for Heat Shrinkable Protection
85C3.82/000X	KM 4 Kit for Crimp Protection
85C3.81/000X	KM 4 Kit for Ribbon Protection
85C3.83/000X	KM 6 Kit for Heat Shrinkable Protection
85C3.85/000X	KM 6 Kit for Crimp Protection
85C3.84/000X	KM 6 Kit for Ribbon Protection

▶ For other variants, please, contact our sales department.



KM 6



KM 4

FibeRoad™ stackable



MDB FA 24/48, 48/96, 72/144

GPON READY 5G READY FibeRoad

The optical distribution box MDB FA 24/48, 48/96, 72/144 is designed for the termination of 24/48/72 fibers to SC connectors or 48/96/144 fibers to LC connectors indoors and outdoors (for trays KM 5). The distribution box can be enhanced by the pole holder and it can store large cable/patchcords reserves.

- ▶ Capacity of up to 72/168/264 splices (for KM 4, KM 6)
- ▶ Capacity of up to 24/48/72× SC or 48/96/144× LC connector (for KM 5)
- ▶ Capacity of up to 24/56/88× SC or 48/112/176× LC connector (for KM 7)
- ▶ Ranging rings
- ▶ Possibility of storing large cable/patchcord reserves inside the distribution box
- ▶ Removable splicing/patching part
- ▶ FibeRoad™ System
- ▶ Possibility of modular increasing of the capacity
- ▶ Possibility of placing PLC Splitters in the management section (outside the tray)
- ▶ KM 4 and KM 6 for up to 24 splices
- ▶ KM 5 for up to 12× SC / 24× LC connector
- ▶ KM 7 for up to 8× SC / 16× LC connector (for GPON)
- ▶ Hinging KM 5, KM 7 tray for a better handling
- ▶ Possibility of ribbon fibers



MDB FA 72/144



MDB FA 24/48

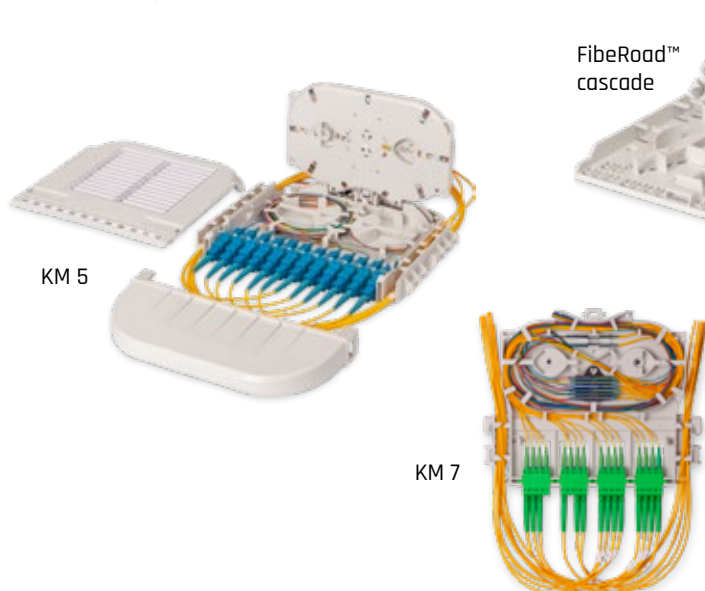

KM 5

KM 7

FibeRoad™ cascade



MDB FA 48/96

TECHNICAL SPECIFICATIONS

Inputs / Outputs (quantity × range)	48× 3 mm, 3× 8–16 mm / 96× 3 mm, 4× 8–16 mm / 144× 3 mm, 4× 8–16 mm
Grommets (type and number of used grommets)	2× PG29, 3× PG16 / 4× PG29, 4× PG16 / 6× PG29, 4× PG16
Ingress Protection	IP65
Impact Protection	IK08
Material	ABS
Color	light gray RAL 7035
Dimensions (H × W × D)	400 × 300 × 170 mm / 500 × 400 × 170 mm / 600 × 400 × 200 mm
Weight	2.9 / 4.6 / 6.2 kg

ORDERING CODES

85TA.50/0000F	MDB FA 24/48
85TA.60/0000F	MDB FA 48/96
85TA.70/0000F	MDB FA 72/144
496041	Key Lock (set of 2 pcs needed)
85C3.79/000X	KM 4 Kit for Heat Shrinkable Protection
85C3.82/000X	KM 4 Kit for Crimp Protection
85C3.81/000X	KM 4 Kit for Ribbon Protection
85AV.94/0000F	KM 5 Kit for Heat Shrinkable Protection
85AV.94/00K2F	KM 5 Kit for Crimp Protection
85AV.94/00R3F	KM 5 Kit for Ribbon Protection
85C3.83/000X	KM 6 Kit for Heat Shrinkable Protection
85C3.85/000X	KM 6 Kit for Crimp Protection
85C3.84/000X	KM 6 Kit for Ribbon Protection
85C3.86/000X	KM 7 Kit for Heat Shrinkable Protection
85C3.88/000X	KM 7 Kit for Crimp Protection
85C3.87/000X	KM 7 Kit for Ribbon Protection

▶ For other variants, please, contact our sales department.

ORU 1, ORU 2, ORU 3

GPON READY
5G READY
SAFeTNET

The optical distribution box ORU 1, 2, 3 is designed as a multi-purposed distributor with hinged rack for assembly up to 4, 16, 24 splice modules SAFeTNET for terminating or connecting of optical cables in micro-ducts or HDPE protecting pipes. Its construction enables using indoors and outdoors as well.

- ▶ Maximum capacity 144, 576, 864 optical splices
- ▶ Maximum number of splice modules SAFeTNET 4, 16, 24 pcs.
- ▶ Placement of optical fiber reserve, length 2.15 m, 3 m, 4 m
- ▶ Possibility of connector panel installation for measurement
- ▶ Possibility of oval grommet installation for undivided cable (so-called „OMEGA“)
- ▶ Removable roof



ORU 1



ORU 2



ORU 3

ORDERING CODES

8507.00/000NF	ORU 1
8508.00/000NF	ORU 2
8509.00/000NF	ORU 3
8521.08/BALOF	Post Brackets

▶ For other variants, please, contact our sales department.

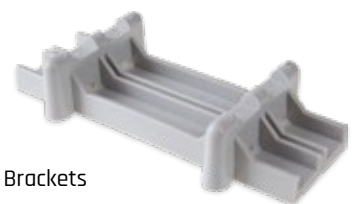

Post Brackets

TECHNICAL SPECIFICATIONS

	ORU 1	ORU 2	ORU 3
Inputs / Outputs (quantity × range)	3× 23–46 mm, 4× 9–24 mm	5× 23–46 mm, 3× 9–24 mm, 1× 15–19 mm / 21–25 mm, 3× 8–12 mm	12× 23–46 mm
Grommets (type and number of used grommets)	3× rubber grommet ø 50 mm, 4× rubber grommet ø 30 mm	5× rubber grommet ø 50 mm, 3× rubber grommet ø 30 mm, 1× PG29, 3× PG13.5	12× rubber grommet ø 50 mm
Ingress Protection	IP54	IP54	IP54
Impact Protection	IK10	IK10	IK10
UV Resistance	yes	yes	yes
Flammability Degree	V0	V0	V0
Material	glass reinforced polyester SMC	glass reinforced polyester SMC	glass reinforced polyester SMC
Color	light gray RAL 7035	light gray RAL 7035	light gray RAL 7035
Dimensions (H × W × D)	500 × 390 × 350 mm	500 × 550 × 350 mm	900 × 550 × 350 mm
Weight	14 kg	20 kg	23 kg

ACCESSORIES FOR ORU ON THE PAGE 47

SNM 48 SIS, SNM 72 VS SIS, SNM 144 VS SIS

GPON READY 5G READY

The optical overground closures SNM 48 SIS, 72 VS SIS, 144 VS SIS are designed for the termination of 48/72/144 optical splices outdoors. The distribution box is to be installed in an open space in trench. One SNM 48/72 distributor or two SNM 72 distributors can be fitted in plastic corpus of pillar.

- ▶ Maximum capacity is 48/72/144 optical splices
- ▶ Plastic corpus
- ▶ installation – separate pillar
- ▶ Possibility of shortened pillar version
- ▶ Placement of optical fiber reserve, length 2 m
- ▶ Cable holders
- ▶ Management rings
- ▶ PG Grommets



SNM 48 SIS

SNM 72 VS SIS

YouTube

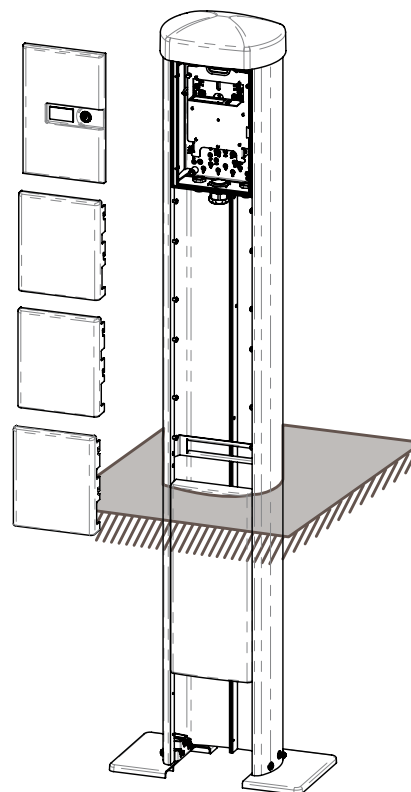

SNM 144 VS SIS

TECHNICAL SPECIFICATIONS

Inputs / Outputs (quantity × range)	4 × 8–12 mm	
Grommets (type and number of used grommets)	4 × PG13.5	
Ingress Protection	IP54	
Impact Protection	IK10	
UV Resistance	yes	
Flammability Degree	V0	
Temperature Range	–40 °C / +70 °C	
Material	PVC, PC / ABS	
Color	light gray RAL 7035	
Dimensions (H × W × D)	SNM 48 SIS	1,747 × 290 × 209 mm
	SNM 72 VS SIS	1,747 × 290 × 209 mm
	SNM 144 VS SIS	2,147 × 290 × 209 mm
Weight	SNM 48 SIS	11 kg
	SNM 72 VS SIS	11 kg
	SNM 144 VS SIS	16 kg

ORDERING CODES

85F0.10/0000F	SNM 48 SIS
85HC.20/0000F	SNM 72 VS SIS
85LG.10/0000F	SNM 144 VS SIS

▶ For other variants, please, contact our sales department.

ORM 16 SDF SIS

GPON READY 5G READY

The optical distribution box ORM 16 SDF SIS is designed for splicing, connectors connection and placing the splitter 1:8, 1:16. The box is ideal for FTTx applications.

- ▶ Capacity of 16 optical connectors
- ▶ Connector holder SC simplex, SC duplex
- ▶ Extra 2 optional adapter positions for connecting the input optical cable with splitter, or for measurement over one fiber outgoing from the splitter.
- ▶ 1–2 KM 1 optical splice trays for splices placing
- ▶ 2× space for routing of incoming and outgoing fibers
- ▶ Optical connector holder 8× SC/DX + 1× SC/ SX

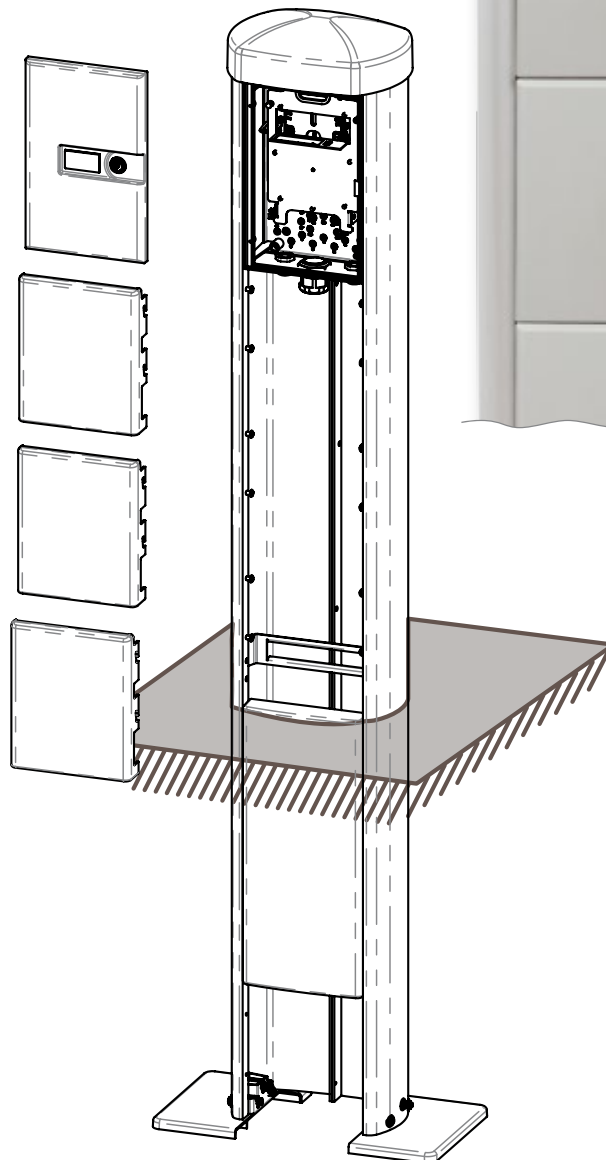

TECHNICAL SPECIFICATIONS

Inputs / Outputs (quantity × range)	24× 3 mm, 2× 8–12 mm
Grommets (type and number of used grommets)	1× PG29, 2× PG13.5
Ingress Protection	IP54
Impact Protection	IK10
UV Resistance	yes
Flammability Degree	V0
Temperature Range	–40 °C / +70 °C
Material	PVC, PC / ABS
Color	light gray RAL 7035
Dimensions (H × W × D)	1,747 × 290 × 209 mm
Weight	11 kg

ORDERING CODES

8588.80/S100F	ORM 16 SDF SIS with optical connector holder 16× SC/E2000
---------------	--

- ▶ For other variants, please, contact our sales department.

MDP OZ 144/288/432S



The optical pillar closure MDP OZ 144/288/432S is designed for the placement of 144/288/432 optical splices outdoors. The pillar is to be installed in open space in trench. The cabinet is supplied without the splice trays. The solution is recommended for spliced GPON networks.

- ▶ Compact solution (footprint 264 × 245 mm)
- ▶ Modular pillar height based on the maximum capacity
- ▶ Three-point lock door
- ▶ Duct holder in the basement
- ▶ Cable rings for placing cable reserves
- ▶ Hingeable/detachable splicing plate
- ▶ FibeRoad™ System
- ▶ Possibility of adding trays as your network grows
- ▶ Possibility of placing PLC splitters in the management (outside the trays)
- ▶ Suitable for spliced GPON networks
- ▶ Tray KM 4 or KM 6 for 24 splices
- ▶ Optional ribbon splice holders
- ▶ Possibility of loop cable

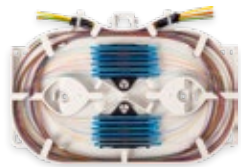

KM 6



KM 4



FibeRoad™ System



MDP OZ 432S



MDP OZ 144S



MDP OZ 288S

TECHNICAL SPECIFICATIONS

Inputs / Outputs (quantity × range)	32× 1–5 mm, 4× 3–13 mm
Grommets (type and number of used grommets)	2× express port
Ingress Protection	IP54
Impact Protection	IK10
Material	polyester / glass fibre
Color	light gray RAL 7035
Dimensions (H × W × D)	1,300 / 1,500 / 1,700 × 245 × 264 mm
Weight	14 / 17 / 20 kg

ORDERING CODES

85GB.00/0000F	MDP OZ 144S
85GB.20/0000F	MDP OZ 288S
85GB.40/0000F	MDP OZ 432S
495630	Cable base (extension leg pillar)
85C3.79/000X	KM 4 Kit for Heat Shrinkable Protection
85C3.82/000X	KM 4 Kit for Crimp Protection
85C3.81/000X	KM 4 Kit for Ribbon Protection
85C3.83/000X	KM 6 Kit for Heat Shrinkable Protection
85C3.85/000X	KM 6 Kit for Crimp Protection
85C3.84/000X	KM 6 Kit for Ribbon Protection

▶ For other variants, please, contact our sales department.

MDP OZ 24/48, 48/96, 72/144

GPON READY 5G READY FibeRoad

The optical pillar MDP OZ 24/48, 48/96, 72/144 is designed for the placement of 24/48/72 SC connectors or 48/96/144 LC connectors outdoors (for trays KM 5). The pillar is to be installed in open space in trench. The cabinet is supplied without the splice trays. The solution is recommended for spliced GPON networks.

- ▶ Capacity of up to 72/168/264 splices (for KM 4, KM 6)
- ▶ Capacity of up to 24/48/72× SC or 48/96/144× LC connector (for KM 5)
- ▶ Capacity of up to 24/56/88× SC or 48/112/176× LC connector (for KM 7)
- ▶ Compact solution (footprint 264 × 245 mm)
- ▶ Modular pillar height based on the maximum capacity
- ▶ Three-point lock door
- ▶ Duct holder in the basement
- ▶ Cable rings for placing cable reserves
- ▶ Hingeable/detachable splicing/patching plate
- ▶ FibeRoad™ System
- ▶ Possibility of adding trays as your network grows
- ▶ Possibility of placing PLC splitters in the management (outside the trays)
- ▶ Possibility to combine trays KM 4, KM 5, KM 6, KM 7
- ▶ KM 4 and KM 6 for up to 24 splices
- ▶ KM 5 for up to 12× SC / 24× LC connector
- ▶ KM 7 for up to 8× SC / 16× LC connector (for GPON)
- ▶ Optional ribbon splice holders
- ▶ Possibility of loop cable
- ▶ Max. 4 pcs PLC Splitters ABS



KM 5

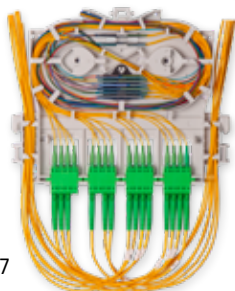

KM 7



MDP OZ 72/144

TECHNICAL SPECIFICATIONS

Inputs / Outputs (quantity × range)	32× 1–5 mm, 4× 3–13 mm
Grommets (type and number of used grommets)	2× express port
Ingress Protection	IP54
Impact Protection	IK10
Material	polyester / glass fibre
Color	light gray RAL 7035
Dimensions (H × W × D)	1,300 / 1,500 / 1,700 × 245 × 264 mm
Weight	14 / 17 / 20 kg



MDP OZ 72/144

ORDERING CODES

85GB.10/0000F	MDP OZ 24/48
85GB.30/0000F	MDP OZ 48/96
85GB.50/0000F	MDP OZ 72/144
495630	Cable base (extension leg pillar)
85C3.79/000X	KM 4 Kit for Heat Shrinkable Protection
85C3.82/000X	KM 4 Kit for Crimp Protection
85C3.81/000X	KM 4 Kit for Ribbon Protection
85AV.94/0000F	KM 5 Kit for Heat Shrinkable Protection
85AV.94/00K2F	KM 5 Kit for Crimp Protection
85AV.94/00R3F	KM 5 Kit for Ribbon Protection
85C3.83/000X	KM 6 Kit for Heat Shrinkable Protection
85C3.85/000X	KM 6 Kit for Crimp Protection
85C3.84/000X	KM 6 Kit for Ribbon Protection
85C3.86/000X	KM 7 Kit for Heat Shrinkable Protection
85C3.88/000X	KM 7 Kit for Crimp Protection
85C3.87/000X	KM 7 Kit for Ribbon Protection

▶ For other variants, please, contact our sales department.

ORU 1 SIS, ORU 2 SIS, ORU 3 SIS

GPON READY
5G READY
SAFeTNET

The optical distribution box ORU 1, 2, 3 SIS is designed as a multi-purposed distributor with hinged rack for assembly up to 4, 16, 24 splice modules SAFeTNET for terminating or connecting of optical cables in micro-ducts or HDPE protecting pipes. Its construction enables using outdoors. With a simple holder it could be mounted on a pillar. The ORU 1, 2, 3 SIS are installed in an open area in trench.

- ▶ Maximum capacity 144, 576, 864 optical splices
- ▶ Maximum number of splice modules SAFeTNET 4, 16, 24 pcs.
- ▶ Placement of optical fiber reserve, length 2.15 m, 3 m, 4 m
- ▶ Possibility of connector panel installation for measurement
- ▶ Possibility of oval grommet installation for undivided cable (so-called „OMEGA“)
- ▶ Different sizes of the basement, heights 300, 500, 600, 700, 900 mm
- ▶ Removable roof



ORU 3 SIS BESTSELLER



ORU 1 SIS



ORU 2 SIS



Underground Base

ORDERING CODES

8507.00/000SF	ORU 1 SIS
8508.00/000SF	ORU 2 SIS
8509.00/000SF	ORU 3 SIS

▶ For other variants, please, contact our sales department.

TECHNICAL SPECIFICATIONS

	ORU 1 SIS	ORU 2 SIS	ORU 3 SIS
Inputs / Outputs (quantity × range)	3× 23–46 mm, 4× 9–24 mm	5× 23–46 mm, 3× 9–24 mm, 1× 15–19 mm / 21–25 mm, 3× 8–12 mm	12× 23–46 mm
Grommets (type and number of used grommets)	3× rubber grommet ø 50 mm, 4× rubber grommet ø 30 mm	5× rubber grommet ø 50 mm, 3× rubber grommet ø 30 mm, 1× PG29, 3× PG13.5	12× rubber grommet ø 50 mm
Ingress Protection	IP54	IP54	IP54
Impact Protection	IK10	IK10	IK10
UV Resistance	yes	yes	yes
Flammability Degree	V0	V0	V0
Material	glass reinforced polyester SMC	glass reinforced polyester SMC	glass reinforced polyester SMC
Color	light gray RAL 7035	light gray RAL 7035	light gray RAL 7035
Dimensions (H × W × D)	1,200 × 390 × 350 mm	1,200 × 550 × 350 mm	1,600 × 550 × 350 mm
Weight	39 kg	45 kg	53 kg

ORU 1 SDF SIS

BESTSELLER **GPON READY** **5G READY** **SAFeTNET**

The ORU 1 SDF SIS is designed as splitter concentrator pillar distributor with hinged rack for assembly up to 4 splice modules SE for terminating or connecting of optical cables in micro-ducts or HDPE protecting pipes. Its construction enables using outdoors as well. It is installed in an open space in trench.

- ▶ Maximum capacity 144 optical splices
- ▶ Maximum connected capacity 64 optical fibers
- ▶ Maximum number of splice modules SAFeTNET 4 pcs.
- ▶ Maximum number of splitters 2 pcs.
- ▶ Placement of optical fiber reserve, length 4 m
- ▶ Different sizes of the basement, heights 300, 500, 600, 700, 900 mm
- ▶ Removable roof
- ▶ Possibility of placing ABS splitter



TECHNICAL SPECIFICATIONS

Inputs / Outputs (quantity × range)	3× 23–46 mm, 4× 9–24 mm
Grommets (type and number of used grommets)	3× rubber grommet ø 50 mm, 4× rubber grommet ø 30 mm
Ingress Protection	IP54
Impact Protection	IK10
UV Resistance	yes
Flammability Degree	V0
Material	glass reinforced polyester SMC
Color	light gray RAL 7035
Dimensions (H × W × D)	1,200 × 390 × 350 mm
Weight	44.5 kg

ORDERING CODES

8508.60/5000F ORU 1 SDF SIS (with rubber grommets)

- ▶ For other variants, please, contact our sales department.

LGX module
with splitter

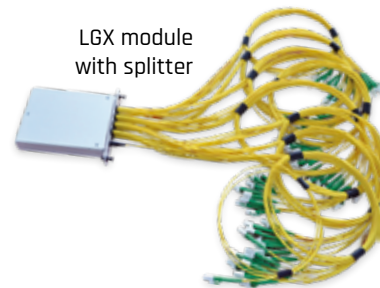

PLC ABS
splitter shelf



Underground Base

ORU 5 SDF SIS

GPON READY
5G READY
SAFeTNET

The ORU 5 SDF SIS is designed as splitter concentrator pillar distributor with hinged rack for assembly up to 12 splice modules SE for terminating or connecting of optical cables in micro-ducts or HDPE protecting pipes. Its construction enables using outdoors. It is installed in an open space in trench.

- ▶ Maximum capacity 432 optical splices
- ▶ Maximum connected capacity 288 optical fibers
- ▶ Maximum number of splice modules SAFeTNET 12 pcs.
- ▶ Maximum number of splitters 5 pcs.
- ▶ Placement of optical fiber reserve, length 4 m
- ▶ Different sizes of the basement, heights 300, 500, 600, 700, 900 mm
- ▶ Removable roof
- ▶ Possibility of placing ABS splitter



TECHNICAL SPECIFICATIONS

Inputs / Outputs (quantity × range)	5× 36–44 mm, 2× 15–25 mm, 6× 8–12 mm, 1× 5–8.5 mm
Grommets (type and number of used grommets)	5× PG48, 2× PG29, 6× PG13.5, 1× PG9
Ingress Protection	IP54
Impact Protection	IK10
UV Resistance	yes
Flammability Degree	V0
Material	glass reinforced polyester SMC
Color	light gray RAL 7035
Dimensions (H × W × D)	1,600 × 550 × 350 mm
Weight	53 kg

ORDERING CODES

8508.44/0000F ORU 5 SDF SIS

- ▶ For other variants, please, contact our sales department.

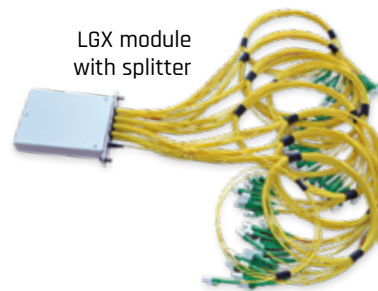

LGX module with splitter



Underground Base

ACCESSORIES FOR ORU, ORU SIS



ORDERING CODES

Ordering Code	Description	Position
8506.34/0000F	Microtubes holder 24x3 mm + 3x5 mm	
8506.35/0000F	Microtubes holder 36x3 mm + 3x10 mm	
8506.31/0000F	Microtubes holder 24x5 mm + 3x10 mm	1
8506.32/0000F	Microtubes holder 10x7 mm	
8506.33/0000F	Microtubes holder 9x10 mm	
8506.14/0000F	Holder of tension element – 3 pcs.	2
8507.52/0000F	Holder of thick-walled microducts	3
8299.12/0100	Fastening belt holder	4
8555.15//0000F	Grommet ø 50 mm, 7x10 mm	5
8555.12/0000F	Grommet ø 50 mm, 7x12 mm	6
8555.16/0000F	Grommet ø 50 mm, 7x14 mm	7
8506.41/0000F	Rings holder + rings for ORU 2	8
8506.46/0000F	Rings holder + rings for ORU 3	9
8507.42/0000F	Measuring panel 6x SC ORU	10
8508.31/0000F	Panel ORU 18x SC	11
490360	Strap SCOTCHFLEX 20 mm x 10 m	–
8506.42/0000F	Tightening strap – 15 pcs.	–
8506.38/0000F	Tightening strap – 100 pcs.	–
8506.39/0000F	Holder of splice tray modules for ORU 2	12
8506.47/0000F	Holder of splice tray modules for ORU 3	13
8508.38/0100F	Assembly stand for ORU	14
85BV.03/0000F	Resin pack 50 ml + adapter kit	15+16
493615UP	Putty COMPOUND 16A, 500g	17
490985	Cable holders 8–12 mm	19
490986	Cable holders 12–16 mm	–
087500	Cable holders 16–22 mm	–
103300	Cable holders 22–28 mm	–
087600	Cable holders 28–34 mm	–
073300	Cable holders 34–40 mm	–
490993	Cable holders 28–34 mm	18
490994	Cable holders 34–40 mm	–

► For other variants, please, contact our sales department.

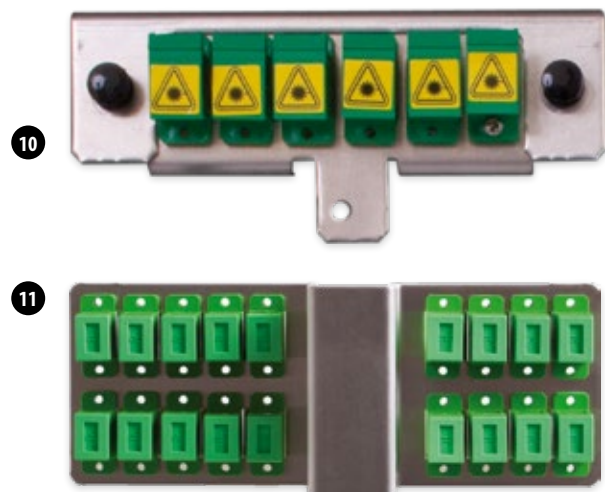

ACCESSORIES FOR ORU SIS



COYOTE® DTC

The COYOTE® DTC (Drop Termination Closure) offers a compact size and a rugged exterior that is designed to allow for installation in tight spaces without compromising functionality. Four corner ports provide flexibility during installation. The COYOTE® DTC is ideal for quick restoration of damaged or cut fiber service drops or last mile FTTH applications.

- ▶ Dimensions: 231 × 193 × 43 mm
- ▶ Max Splice Capacity: 24 Single Fusion
- ▶ Max Adapter Quantity: 2 SC or 2 Dual LC
- ▶ Utilizes the LITE-GRIP® Splice Block System which permits single fusion, mass fusion, mechanical, PLC splitters, or a combination of all within one closure
- ▶ Factory-installed gasket allows re-entry and re-use
- ▶ Internal organizer manages buffer tube or ribbon cables
- ▶ Snap together design is quick to assemble, no special tools required
- ▶ Designed and tested in accordance to Telcordia® GR-771-CORE Buried, Underground, IP-68 Rated Requirements



COYOTE® DTC4/DTC6

The COYOTE® DTC4 and DTC6 (Drop Termination Closure) offer a durable, compact solution with multiple internal fiber organizers to support your current and future needs. Network evolution is unpredictable so why not choose a closure system developed to adapt. The DTC4 can be used as a transition unit for interior duct applications. Both the COYOTE® DTC4 and DTC6 can equip an adapter bulkhead tray that hinges to allow access to the underlying fiber slack storage area.

- ▶ Dimensions: 274 × 198 × 82 mm
- ▶ Max Splice Capacity: 24 Single Fusion
- ▶ Max Adapter Quantity: 4 Dual SC or 4 Quad LC
- ▶ Grommet Quantity: 4 or 6 (Multi-Hole Grommets Available)
- ▶ Grommet Cable Diameter Range:
Large Grommets = 3 – 15 mm
Small Grommets = 2.4 – 10.7 mm and Flat Drop
- ▶ Applications: Direct Bury, Below Grade, Pole/Wall Mount, Pedestal, Aerial, or Interior Applications
- ▶ Designed and tested in accordance to Telcordia® GR-771-CORE Buried, Underground, IP-68 Rated Requirements
- ▶ Constructed out of rugged UV-stabilized, flame-retardant material (UL94-5VA Rated)
- ▶ Hinged cover with integrated over-mold creates a secure seal and provides quick re-entry and re-use



COYOTE® LCC

The COYOTE® LCC (Low Count Closure) is a compact closure that utilizes the COYOTE® silicone grommet system and LITE-GRIP® splice platform, is designed making this rugged closure the ideal economical solution for new drop cable installations and critical repair situations.

- ▶ Dimensions: 356 × 165 × 64 mm
- ▶ Max Splice Capacity: 24 Single Fusion
- ▶ Max Adapter Quantity: 2 Dual SC or 2 Quad LC
- ▶ Offers a cost-effective solution for quick restoration of damaged or cut fiber service drops
- ▶ Utilizes the LITE-GRIP® splice block system which permits single fusion, mechanical, PLC splitters, or a combination of all within one closure
- ▶ Factory installed gasket allows for re-entry and re-use
- ▶ LCC halves are constructed of a UV-stabilized material
- ▶ Flexible grommet sealing technology supports a wide range of flat and round cable profiles
- ▶ Flat shape allows for mounting in small areas
- ▶ Flame-retardant and ribbon kits available
- ▶ Designed and tested in accordance to Telcordia® GR-771-CORE Buried, Underground, IP-68 Rated Requirements



COYOTE® IN-LINE RUNT

The COYOTE® In-Line RUNT Closure has the versatility to be used in both distribution and fiber-to-the-premise (FTTP) networks for in-line or butt applications. The compact size allows for placement in small handholes and pedestals.

- ▶ Dimensions: 475 × 254 × 94 mm
- ▶ Max Splice Capacity: 196 Single Fusion
- ▶ Max Adapter Quantity: 8 SC or 8 Dual LC
- ▶ Internal organizer manages buffer tube or ribbon
- ▶ Multiple splice tray designs support mass fusion splicing, single fusion splicing, or a combination of both
- ▶ Flexible grommet sealing technology supports a wide range of flat and round cable profiles
- ▶ Factory-installed gasket allows re-entry and re-use
- ▶ Flame-retardant kits available
- ▶ Designed and tested in accordance to Telcordia® GR-771-CORE Buried, Underground, IP-68 Rated Requirements



COYOTE® HD DOME

The COYOTE® HD (High-Density) Dome Closure offers an alternative fiber organizer to support high-density splice applications within the same footprint as PLP's existing 9.5" × 28" COYOTE® Dome Closure. The new organizer architecture provides open access for fiber routing, reduces cable sheath openings, and simplifies assembly: all factors that save you time and money. When combined with PLP's patented segmented end plate design, the closure system offers the ultimate level of flexibility to address your complex network needs.

- ▶ Maximum Splice Capacity of 1728 or 3456 depending on cable construction
- ▶ 7-Port segmented end plate design provides independent access to each cable port without disrupting surrounding cables
- ▶ Two splice tray designs to support mass fusion splicing, single fusion, or a combination of both
- ▶ Modular tray design permits trays to hinge upward or be removed from the stack to allow multiple splicers to work simultaneously
- ▶ Designed and tested in accordance to Telcordia® GR-771-CORE Buried, Underground, IP-68 Rated Requirement

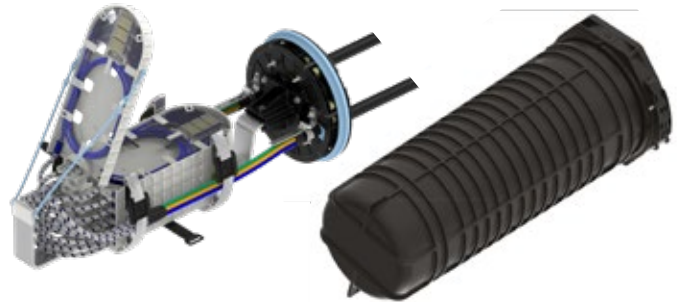

ROMIE

The ROMIE cabinets represent a smart solution for easing the access between the operator network and the internal network at the multi dwelling. They can be independently installed by different operators, starting from one secondary unit installed, part of the building, and a second unit, called primary, owned by one operator. Units can be coupled each other, so that several operators can be connected to the inner building network, while having visible their own structure. Cabinets have been designed to provide easy installation, to be craft-friendly and to have reduced visual impact.

- ▶ Dimensions: 323 × 72 × 150 mm / 323 × 105 × 150 mm
- ▶ Max Splice Capacity: 32 / 56 Single Fusion
- ▶ Max Adapter Quantity: 32 / 56 SC
- ▶ It is possible to install several units, depending on the typology
- ▶ Independent compartments
- ▶ Cable access by side, top or bottom
- ▶ 30mm bending radius guarantee
- ▶ Cabinets are supplied with kit of accessories to complete the installation
- ▶ RAL 1015 Color, other colors possible if required
- ▶ They can be customised with customer's logo at the door (maximum size 30 × 30 mm)



COYOTE® STP-JR

GPON READY 5G READY

The Fiber Optic Closure COYOTE® STP-JR is a highly reliable, small scale, cost effective closure which provides a flexible alternative to traditional network interface devices. The closure has a robust latch system, paired with an integrated over moulded cover. This allows for effortless re-entry and creates a secure seal over a wide range of cable profiles.

When every splice counts, operators are increasingly appreciating robust closures with no nonsense fiber routing to ensure that they can maintain the high level of service and performance that today's customers demand.

By manufacturing from high strength materials and subjecting to stringent thermocycle and ingress protection tests, the STP-JR is a built-to-last closure protecting fiber optic splices from water ingress, even when permanently immersed in water. Our IP68 rating is not just a statement, it is a testimony of a product that has been engineered, tried and tested.

- ▶ Capacity of up to 12 splices
- ▶ Capacity of up to 2x SC / 4x LC connector
- ▶ PLC Splitter capability (small format 1:8)
- ▶ Aerial or underground application
- ▶ Increased impact protection and water ingress resistance even when permanently immersed in water (IP68)
- ▶ Grommets system for cables with diameters 2.4–14 mm
- ▶ Support for midspan (loop-through) cable
- ▶ Intuitive installation

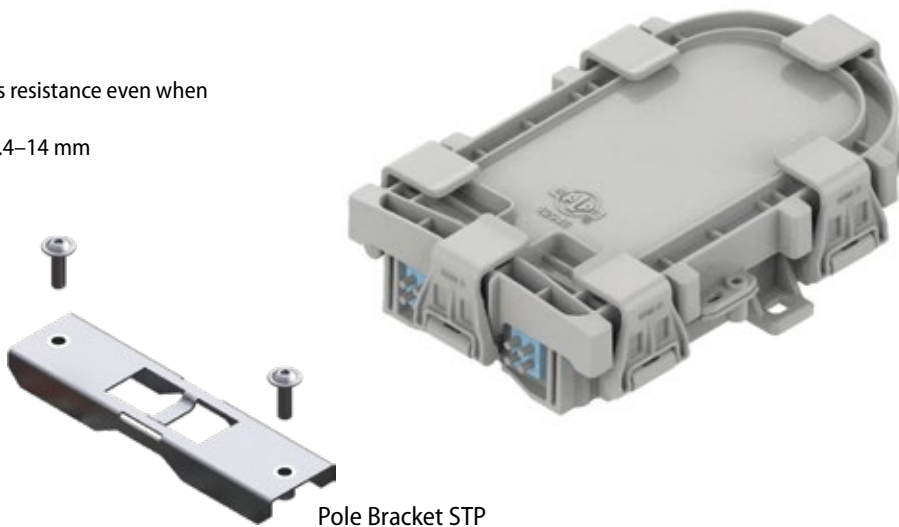

Pole Bracket STP

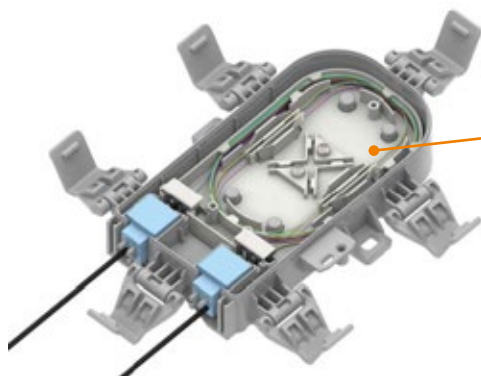

Removable Splice Tray Supporting up to 12 Single Fusion Splices (max. length 60 mm) or 4 Mechanical Splices

COYOTE® STP-JR Splice

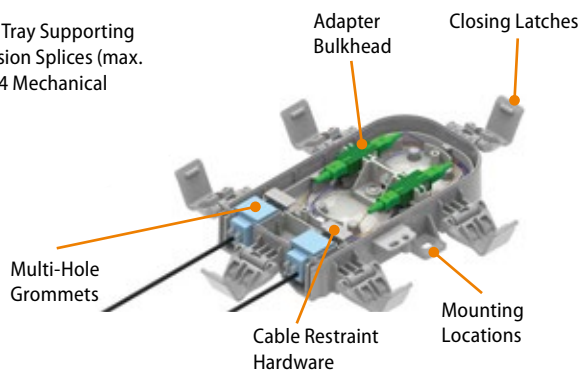

COYOTE® STP-JR Cross-Connect

Section 0
Closure

Section 1
Grommets Selection

Section 2
Organizer Selection

Section 3
Adapter Type Selection

Example: STP JR

CK

1

12

COYOTE® STP JR

XX

X

XX



Select 2 options as below:		Cable Diameter Range
A		SOLID / PLUG Ordering Code 85100013
B		4.3–5.6 mm (round cables) Ordering Code 85100002
C		5.6–6.9 mm (round cables) Ordering Code 85100003
D		6.9–8.1 mm (round cables) Ordering Code 85100004
E		8.1–9.4 mm (round cables) Ordering Code 85100005
F		9.4–10.7 mm (round cables) Ordering Code 85100006
G		10.7–11.9 mm (round cables) Ordering Code 85100007
H		11.9–14.0 mm (round cables) Ordering Code 85100008
J		4.0–4.3 mm (round drop cables) Ordering Code 85100009
K		2.4–3.2 mm (round drop cables) Ordering Code 85100010
1		2.4–3.2 mm (round drop cables) 6.9–8.1 mm (round cables) TLG-1 Ordering Code On request

Select 1 option as below:	
1	<p>Splice and Cross-Connect COYOTE® STP JR-NN-1-NO</p> <p>Max. 12 single fusion splices Max. 2 SC connectors Max. 4 LC connectors Ordering Code 85100001</p>

Select 1 option as below with quantity:		Quantity
N	NONE	0
1	<p>SC/APC</p>	1 or 2 Ordering Code CN0002
2	<p>SC/UPC</p>	1 or 2 Ordering Code CN0001
3	<p>LC/APC</p>	1 or 2 Ordering Code CN0006
4	<p>LC/UPC</p>	1 or 2 Ordering Code CN0005

TECHNICAL SPECIFICATIONS

Inputs / Outputs (quantity × range)	2× 2.4–14 mm (follow the Configurator – Section 1 – Grommets Selection)
Grommets (type and number of used grommets)	Grommets System – 2 pcs
Ingress Protection	IP68
Impact Protection	IK10
Flammability Degree	V0
Material	PC
Color	Light gray RAL 7035
Dimensions (H × W × D)	200 × 125 × 49 mm
Weight	0.4 kg

ORDERING CODES

On request	Custom Configuration
Follow the Configurator (Section 1)	Grommets Kit Separately
85100001	COYOTE® STP JR-NN-1-NO
854G.03/000XF	Pole Bracket STP

► For other variants, please, contact our sales department.

COYOTE® STP-MD

▶ GPON READY ▶ 5G READY

The Fiber Optic Closure COYOTE® STP-MD is a tough, compact splice closure which supports straight splice, splice to drop/branch and internal connector solutions. It's ideal for applications in the FTTx distribution network for splice applications of 24 fibers or less and connectivity solutions. It's also ideal for blown fiber cable and microtube cable applications. It supports use of traditional buffer tube cables. The cover latch system allows simple re-entry and keeps the closure watertight, even when permanently immersed in water (IP68).

- ▶ Capacity of up to 24 splices
- ▶ Capacity of up to 4× SC / 8× LC connector
- ▶ PLC Splitter capability (small format 1:8)
- ▶ Aerial or underground application
- ▶ Increased impact protection and water ingress resistance even when permanently immersed in water (IP68)
- ▶ Grommets system for cables with diameters 2.4–14 mm
- ▶ Support for midspan (loop-through) cable
- ▶ Intuitive installation

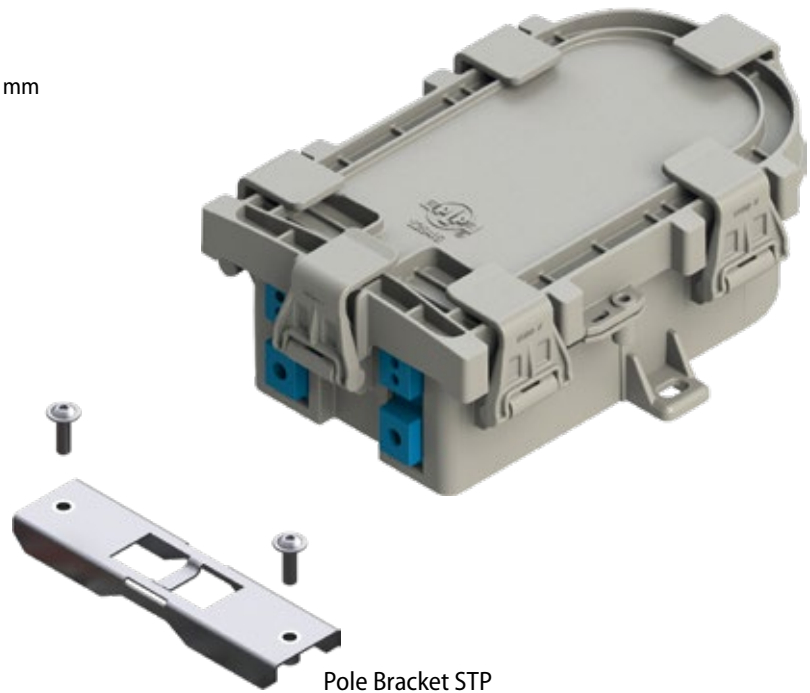

Pole Bracket STP



COYOTE® STP-MD Splice



COYOTE® STP-MD Cross-Connect

COYOTE®
FIBER OPTICS

Section 0
Closure

Example: STP MD

COYOTE® STP MD



Section 1
Grommets Selection

CCKK

XXXX

Select 4 options as below:		Cable Diameter Range
A		SOLID / PLUG Ordering Code 85100013
B		4.3–5.6 mm (round cables) Ordering Code 85100002
C		5.6–6.9 mm (round cables) Ordering Code 85100003
D		6.9–8.1 mm (round cables) Ordering Code 85100004
E		8.1–9.4 mm (round cables) Ordering Code 85100005
F		9.4–10.7 mm (round cables) Ordering Code 85100006
G		10.7–11.9 mm (round cables) Ordering Code 85100007
H		11.9–14.0 mm (round cables) Ordering Code 85100008
J		4.0–4.3 mm (round drop cables) Ordering Code 85100009
K		2.4–3.2 mm (round drop cables) Ordering Code 85100010
1		2.4–3.2 mm (round drop cables) 6.9–8.1 mm (round cables) TLG-1 Ordering Code On request

Section 2
Organizer Selection

1

X

Select 1 option as below:	
1	<p>Splice and Cross-Connect COYOTE® STP MD-NNNN-1</p> <p>Max. 24 single fusion splices Max. 4 SC connectors Max. 8 LC connectors Ordering Code 85100014</p>

Section 3
Adapter Type Selection

14

XX

Select 1 option as below with quantity:		Quantity
N	NONE	0
1	SC/APC 	1 to 4 Ordering Code CN0295
2	SC/UPC 	1 to 4 Ordering Code CN0296
3	LC/APC 	1 to 4 Ordering Code CN0292
4	LC/UPC 	1 to 4 Ordering Code CN0297

TECHNICAL SPECIFICATIONS

Inputs / Outputs (quantity × range)	4× 2.4–14 mm (follow the Configurator – Section 1 – Grommets Selection)
Grommets (type and number of used grommets)	Grommets System – 4 pcs
Ingress Protection	IP68
Impact Protection	IK10
Flammability Degree	V0
Material	PC
Color	Light gray RAL 7035
Dimensions (H × W × D)	200 × 125 × 70 mm
Weight	0.5 kg

ORDERING CODES

On request	Custom Configuration
Follow the Configurator (Section 1)	Grommets Kit Separately
85100014	COYOTE® STP MD-NNNN-1
854G.03/000XF	Pole Bracket STP

► For other variants, please, contact our sales department.

COYOTE® STP-XL

NEW GPON READY 5G READY

The Fiber Optic Closure COYOTE® STP-XL is a flexible closure which provides fast customer connection. The cover latch system allows simple re-entry and keeps the closure watertight, even when permanently immersed in water (IP68). It can be used as an access closure or a distribution closure in FTTx networks.

- ▶ Capacity of up to 192 splices
- ▶ Capacity of up to 24× SC / 48× LC connector
- ▶ Two-section design which provides separate access to the main cable splices and the customer cable splices
- ▶ Hinged splice trays for up to 24 splices (8 pcs max.)
- ▶ Scalable through gradual adding of trays
- ▶ PLC Splitter capability (small format)
- ▶ Support for ribbon fibers
- ▶ Support for midspan (loop-through) cable
- ▶ Grommets system for cables with diameters 2.4–14 mm
- ▶ Increased impact protection and water ingress resistance even when permanently immersed in water (IP68)
- ▶ Optional pole bracket
- ▶ Suitable for all types of networks

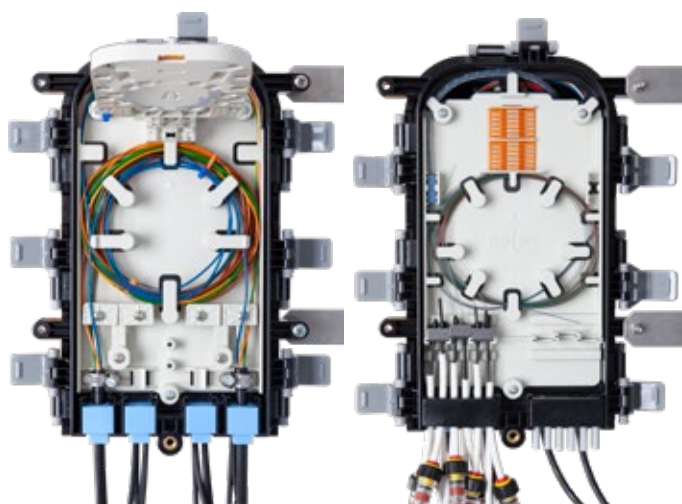
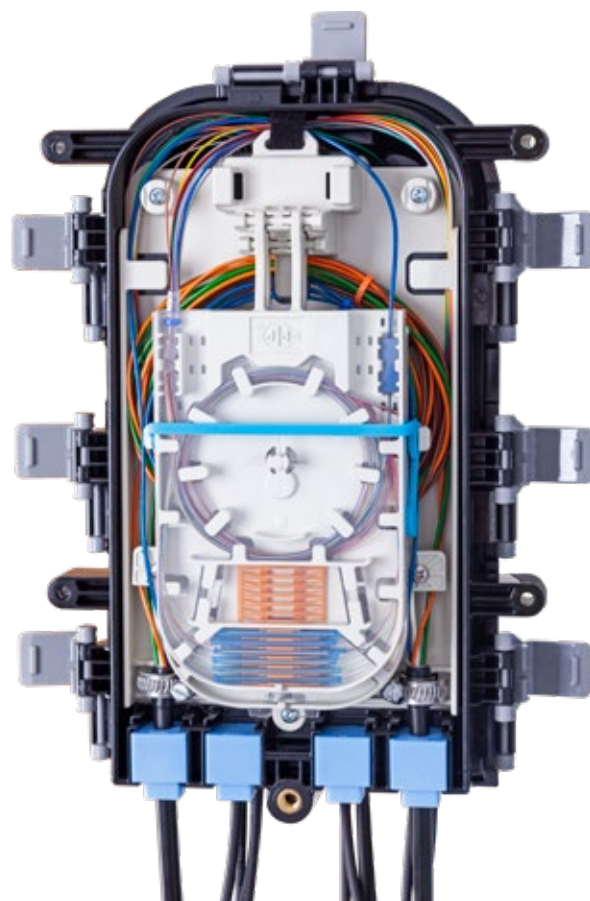

COYOTE® STP-XL
Tray Storage System

COYOTE® STP-XL
Drop Storage System



COYOTE® STP-XL
Cable Reserve Holder



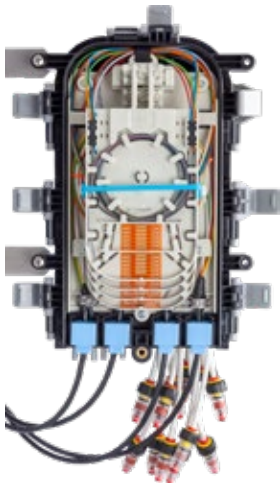

COYOTE® STP XL-E-AAAA-N-BBBB-55-NNN
SPLICING: 96 SPLICES IN THE MAIN SECTION

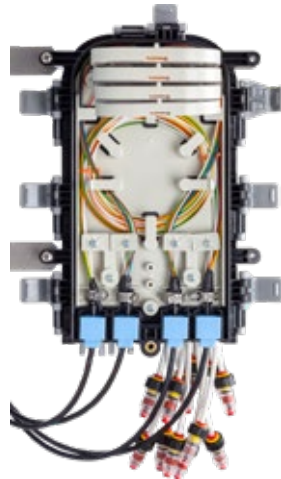

COYOTE® STP XL-G-AAAA-AN-BBBB KKKK-NNN
PATCHING: 12× SC CONNECTOR IN THE DROP SECTION

COYOTE® STP XL-E-AAAA-N-BBBB-55-NNN
SPLICING: 96 SPLICES IN THE MAIN SECTION,
TILTED TRAYS

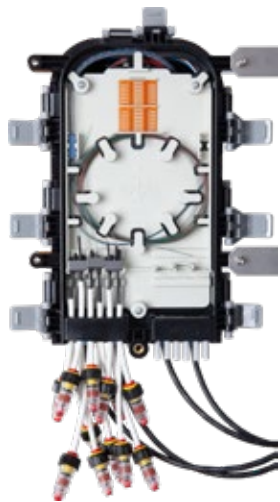

COYOTE® STP XL-D-AA-N-BBBB-55-NNN
SPLICING: 24 SPLICES IN THE DROP SECTION

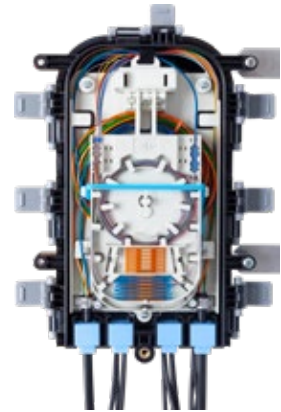

COYOTE® STP XL-G-AANN-A-BBBB KKKK-NNN
SPLICING: 48 SPLICES IN THE MAIN SECTION



Pole and Wall
Bracket STP-XL



Cable Reserve
Holder for STP-XL



Strip to Secure Cover

TECHNICAL SPECIFICATIONS

Inputs / Outputs (quantity × range)	6× or 8× 2.4–14 mm (follow the Configurator – Section 4 – Grommets Selection)
Grommets (type and number of used grommets)	Grommets System – 6 or 8 pcs
Ingress Protection	IP68
Impact Protection	IK10
Material	PC
Color	Black RAL 9005
Dimensions (H × W × D)	300 × 200 × 109/129/149 mm
Weight	2 kg

ORDERING CODES

On request	Custom Configuration
Follow the Configurator (Section 4)	Grommets Kit Separately
Follow the Configurator (Section 1)	Closure with Organizer Separately
Follow the Configurator (Section 2)	Tray Kit Separately
854G.06/000XF	Pole and Wall Bracket STP-XL
854G.11/000XF	Cable Reserve Holder for STP-XL
80813669	High Cover STP-XL, Bracket for 2 Trays, Set

► For other variants, please, contact our sales department.

**Section 0
Closure**

**Section 1
Organizer Selection**

**Section 2
Tray Type Selection**

COYOTE® STP XL



X

Select 1 option as below:

A		2× Low Cover Base 8 Inputs 2× Tray Storage System 85100034
B		1× Low Cover 1× High Cover Base 8 Inputs 2× Tray Storage System 85100035
C		2× High Cover Base 8 Inputs 2× Tray Storage System 85100036
D		2× Low Cover Base 6 Inputs 1× Drop Storage System 1× Tray Storage System 85100037
E		1× Low Cover 1× High Cover Base 6 Inputs 1× Drop Storage System 1× Tray Storage System 85100038
F		2× High Cover Base 6 Inputs 1× Drop Storage System 1× Tray Storage System 85100039
G		2× High Cover Base 8 Inputs 1× Drop Storage System 1× Tray Storage System 85100040

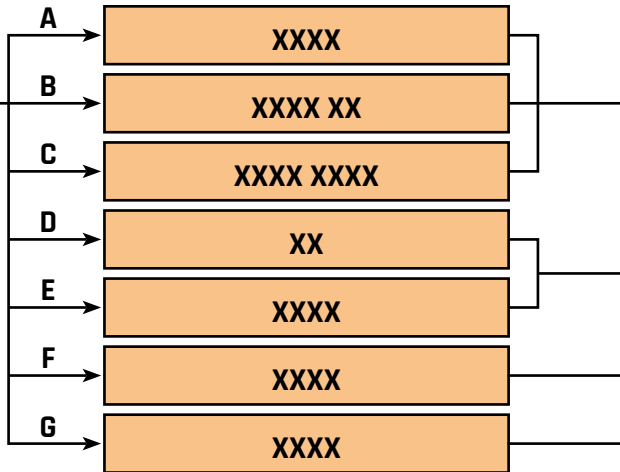

Select trays as below:

A		Tray STP-XL SINGLE FUSION Set 85100019
B		Tray STP-XL Set for Crimp Protection 85100021
C		Tray STP-XL Set for Ribbon Protection 85100020
N	NONE	The position remains empty

Section 3
Adapter Panel Selection

Section 4
Grommets Selection

Section 5
Accessories

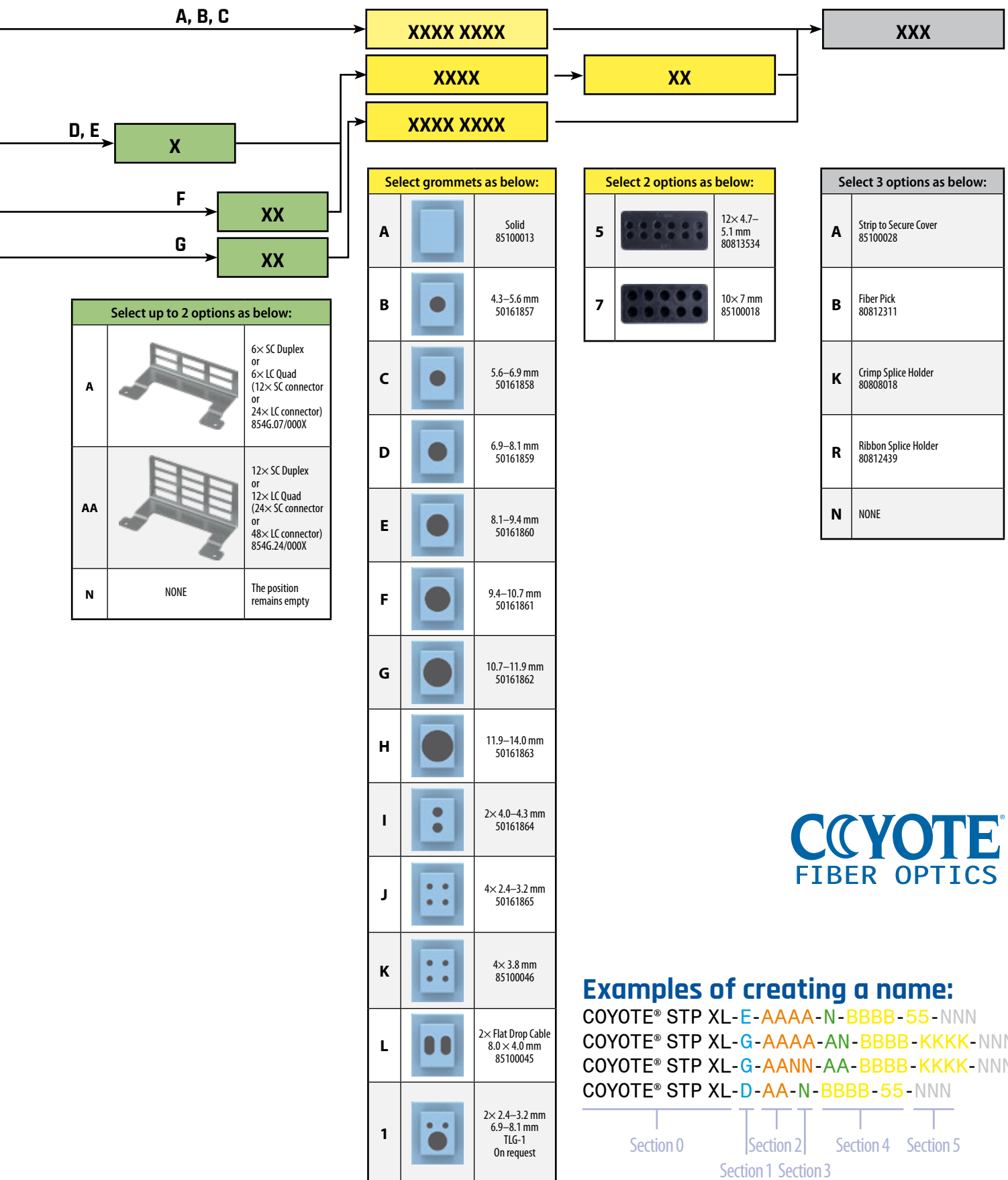

COYOTE® DOME SFMS

NEW GPON READY 5G READY SFMS

The Fiber Optic Closures COYOTE® DOME SFMS are built-to-last closures protecting fiber optic splices from water ingress, even when permanently immersed in water (IP68). The closures have a unique grommets system for easy installation and incorporate the SFMS stacking system to make the fiber management flexible and tidy.

- ▶ Capacity of up to 144 splices (for the COYOTE® DOME ONE)
- ▶ Capacity of up to 384 splices (for the COYOTE® DOME 617)
- ▶ Capacity of up to 576 splices (for the COYOTE® DOME 622)
- ▶ Capacity of up to 768 splices (for the COYOTE® DOME 919)
- ▶ Capacity of up to 1,536 splices (for the COYOTE® DOME 928)
- ▶ Hinged splice trays for up to 12 splices
- ▶ Scalable through gradual adding of trays
- ▶ PLC Splitter capability (small format)
- ▶ Support for ribbon fibers
- ▶ Support for midspan (loop-through) cable
- ▶ Unique grommets system for cables with diameters 2.4–31.8 mm
- ▶ Increased impact protection and water ingress resistance even when permanently immersed in water (IP68)
- ▶ Optional pole and wall bracket
- ▶ Suitable for all types of networks

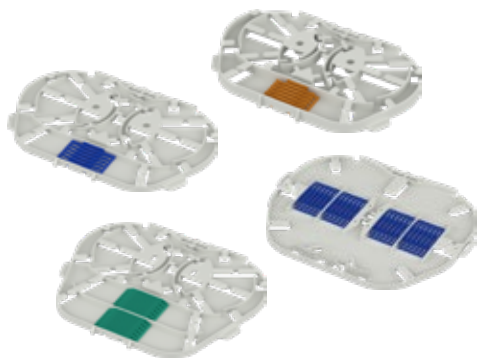

SFMS SYSTEM

- For splicing
- Up to 12 splices
- Only for fibers \varnothing 0.25 mm



GROMMETS SYSTEM

- For cables with diameters 2.4–31.8 mm
- 4× bottom position for the DOME 617, DOME 622
- 7× bottom position for the DOME 919, DOME 928
- 3× bottom position for the DOME ONE



COYOTE® DOME 617 SFMS-A-BBAN-08G_08A



COYOTE® DOME 617 SFMS-A-BBAN-08G_08A
(tilted trays)



COYOTE® DOME 617 SFMS-A-BBAN-08G_08A
(midspan (loop-through) cable installation)



Input into Fiber Organizer

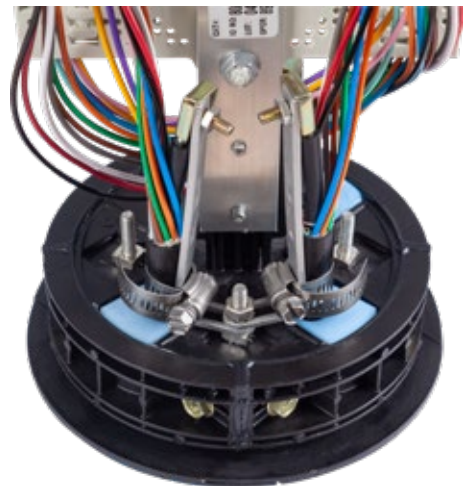

Fiber Optic Cable Fixing

TECHNICAL SPECIFICATIONS

Inputs / Outputs (quantity × range)	4×, 7× or 3× 2.4–31.8 mm (follow the Configurator – Section 2 – Grommets Selection)
Grommets (type and number of used grommets)	Grommets System – 4, 7 or 3 pcs
Ingress Protection	IP68
Impact Protection	IK10
Material	PP
Color	Black RAL 9005
Dimensions (H × ø) DOME 617	463 × 218 mm
Dimensions (H × ø) DOME 622	574 × 218 mm
Dimensions (H × ø) DOME 919	509 × 338 mm
Dimensions (H × ø) DOME 928	749 × 338 mm
Dimensions (H × W × D) DOME ONE	406 × 274 × 145 mm
Weight (DOME 617 / DOME 622 / DOME 919 / DOME 928 / DOME ONE)	4/5/6/7/3 kg

ORDERING CODES

On request	Custom Configuration
Follow the Configurator (Section 2)	Grommets Kit Separately
Follow the Configurator (Section 1)	Closure with Organizer Separately
Follow the Configurator (Section 3)	Tray Kit Separately
58810955	Stainless Pole and Wall Bracket DOME
8003835	Plastic Pole and Wall Bracket DOME
8004004	Stainless Pole and Wall Bracket DOME ONE

► For other variants, please, contact our sales department.

Section 0
Closure

Section 1
Organizer Selection

COYOTE® DOME 617 SFMS



COYOTE® DOME 622 SFMS



COYOTE® DOME 919 SFMS



COYOTE® DOME 928 SFMS





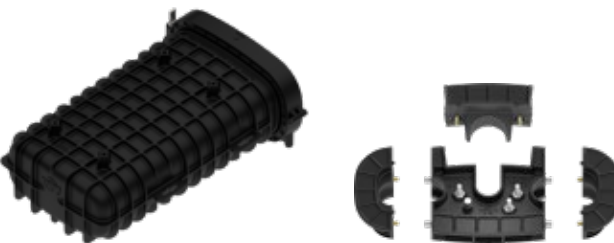



COYOTE® DOME ONE SFMS

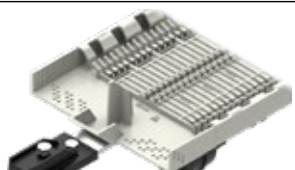

X

Select 1 option as below:

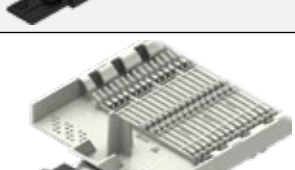





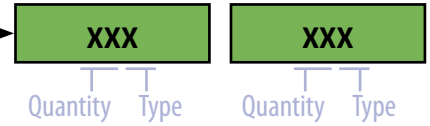
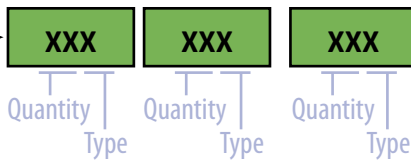
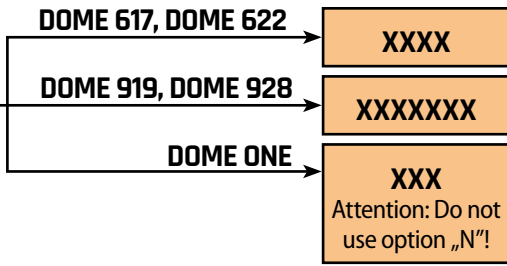



<p>A</p> <p>With fiber organizer Capacity of up to 24× SC tray Capacity of up to 12× SE tray Capacity of up to 288 splices 50161423</p>	
<p>B</p> <p>Without fiber organizer Capacity of up to 32× SC tray Capacity of up to 16× SE tray Capacity of up to 384 splices 85100059</p>	
<p>A</p> <p>With fiber organizer Capacity of up to 40× SC tray Capacity of up to 20× SE tray Capacity of up to 480 splices 50161443</p>	
<p>B</p> <p>Without fiber organizer Capacity of up to 48× SC tray Capacity of up to 24× SE tray Capacity of up to 576 splices 50161444</p>	
<p>A</p> <p>With fiber organizer Capacity of up to 64× SC tray Capacity of up to 32× SE tray Capacity of up to 768 splices 85100061</p>	
<p>A</p> <p>With fiber organizer Capacity of up to 128× SC tray Capacity of up to 64× SE tray Capacity of up to 1,536 splices 85100062</p>	
<p>A</p> <p>With fiber organizer Capacity of up to 16× SC tray Capacity of up to 8× SE tray Capacity of up to 96 splices 50161422</p>	
<p>B</p> <p>Without fiber organizer Capacity of up to 24× SC tray Capacity of up to 12× SE tray Capacity of up to 144 splices 85100060</p>	

**Section 2
Grommets Selection**





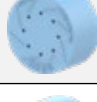

**Section 3
Tray Type Selection**



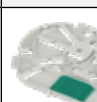

Select grommets as below (please attention to the max. capacity):

A		Grommet, round 45.5, (10.2–15.2 mm) 8003691
B		Grommet, round 45.5, (15.2–21.6 mm) 8003692
C		Grommet, round 45.5, (21.6–25.4 mm) 8003693
D		Grommet, round 45.5, (25.4–31.8 mm) 8003694
E		Grommet, round 45.5, (2x 10.7–15.2 mm) 8003663
F		Grommet, round 45.5, (4x 6.4–7.9 mm) 8004065
G		Grommet, round 45.5, (4x 7.6–10.9 mm) 8003664
H		Grommet, round 45.5, (10.7–15.2 mm, 6x 3.2–6.4 mm) 8003676
I		Grommet, round 45.5, (8x 2.4–3.2 mm) 8004094
J		Grommet, round 45.5, (8x 3.2–6.4 mm) 8003677
K		Grommet, round 45.5, (12x 7 mm) 8004217
N	NONE	The position remains empty. Do not use the option for the DOME ONE!

Select trays as below (please attention to the max. capacity):

A		SC Short, 6F, for heatshrink 80811933
B		SC Short, 12F, for crimp 50161402
C		SE Short, 12F, for heatshrink 80811935
D		SE Short, 4x ribbon or 4x splitter, for ribbon 80812916
E		SC Long, 12F, for heatshrink 80812456
F		SC Long, 24F, for crimp 85100030
G		SC Long, 24F + splitter, for heatshrink 50161971
H		SC Long, 24F + splitter, for crimp 85100031
N	NONE	The position remains empty

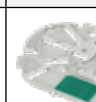
Select trays as below (please attention to the max. capacity):

A		SC Short, 6F, for heatshrink 80811933
B		SC Short, 12F, for crimp 50161402
C		SE Short, 12F, for heatshrink 80811935
D		SE Short, 4x ribbon or 4x splitter, for ribbon 80812916



Examples of creating a name:

COYOTE® DOME 617 SFMS-A-ABCD-05A_02G

COYOTE® DOME 919 SFMS-A-ABCFGNN-11A_14D_07H

COYOTE® DOME ONE SFMS-B-AKL-12A_06H



MUC 160, MUC 250

GPON READY **5G READY**

The MUC 160 and MUC 250 underground chambers offer a cost effective solution for connecting fibres in FTTx networks. It is installed exclusively on the customer's land and is used for the installation and protection of spares and the subsequent connection of fibres. The chamber is designed for micro duct systems.

- ▶ Easy installation
- ▶ Load-free chamber for use on the customer's land (MUC 160)
- ▶ Without lock / Screw lock
- ▶ The ORM 3 distribution box is fixed to a stainless steel holder under the lid
- ▶ Capacity of 12/24 optical splices
- ▶ Integrated fibre management
- ▶ Possibility of the installation 1:4 or 1:8 PLC splitter
- ▶ Used for fibres G.657 a,b
- ▶ Possible express port or PG grommets
- ▶ PG 7 grommets 3× Ø 2.5–6.5 mm
- ▶ Optional 6× PG grommet (MUC 250)
- ▶ Maximum capacity of 9/18 cables Ø 1.6–2.6 mm



MUC 160



MUC 250



MUC 160
Installation
video



MUC 250
Installation
video

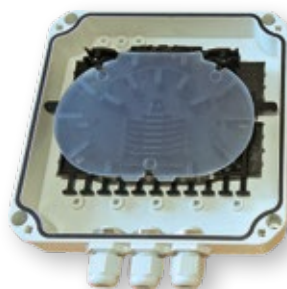

ORM 3 SL 12S



ORM 3 SH 24 S



TECHNICAL SPECIFICATIONS

	MUC 160	MUC 250
Inputs / Outputs (quantity × range)	3× 3–6.5 mm	3× 3–6.5 mm
Grommets (type and number of used grommets)	3× PG7	3× PG7
Ingress Protection	IP67	IP67
Material	PP / PC	HDPE
Color	black RAL 9005	green RAL 6002
Dimensions (H × W × D)	ø 160 × 235 mm	ø 250 × 265 mm
Weight	1 kg	2.5 kg

ORDERING CODES MUC 160

85BD.10/0000F	MUC 160 SL 12S PG
494117	Sealing insert for PG7 3× Ø 1.6 – 2.6 mm

▶ For other variants, please, contact our sales department.

ORDERING CODES MUC 250

85BE.16/0000F	MUC 250 SH 24S PG
85BV.25/0000F	PG 7
494117	Sealing insert for PG7 3× Ø 1.6 – 2.6 mm
85BV.25/0MVLF	PG 7 (3× 1.6–2.6 mm)

▶ For other variants, please, contact our sales department.

MUC Cube 320

The MUC Cube 320 is a purpose designed mini access box, or boundary box, that will cater for low fibre count connections. The MUC Cube 320 is normally used to connect MDU's or single use Clients from the network.

- ▶ Ideal for low density traffic installations. Depending on splitter configuration, up to 12 clients can be connected
- ▶ The unit can be split between base or pan and chamber section to allow installation over existing networks
- ▶ Low footprint unit 250 × 230 mm
- ▶ No tools required for assembly – press-on clips complete the assembly
- ▶ Duct ports are sealed with rubber grommets allowing interface with MultiDuct and/or MicroDuct. No foaming agent or additional sealants are required
- ▶ Knock-down design allows high packing density for transport savings
- ▶ Hingeless slide-in lid with nylon lanyard



MUC Cube 320

Products suitable for installation in MUC Cube 320 chamber:



ORM 3 PG



COYOTE® STP-JR



COYOTE® STP-MD



COYOTE® DTC

TECHNICAL SPECIFICATIONS

Grommets (type and number of used grommets)	cable inlet
UV Resistance	yes
Material	polypropylen
Color	black RAL 9005
Dimensions (H × W × D)	250 × 230 × 310 mm
Weight	3.5 kg



UHD ORMP 1U/2U

NEW **5G READY**

The Ultra High Density Fiber Optic Patch Panel UHD ORMP 1U and UHD ORMP 2U are pre-assembled according to your exact specifications to begin splicing right out of the carton, so it provides substantial labor savings. Each patch panel is made of rugged alu-zinc metal and has a durable powder-coat finish coming in light gray color. The craft-friendly Fiber Optic Trays COYOTE® and an integrated fiber storage allow comfortable assembly.

- ▶ Capacity up to 144 splices (for 1U version)
- ▶ Capacity up to 288 splices (for 2U version)
- ▶ Capacity up to 72× SC / 144× LC connector (for 1U version)
- ▶ Capacity up to 144× SC / 288× LC connector (for 2U version)
- ▶ Increased corrosion resistance (alu-zinc material)
- ▶ High connector density (UHD = Ultra High Density)
- ▶ Removable patchcord support
- ▶ Depth adjustable 19" mounting brackets
- ▶ Including 3 large Fiber Optic Trays with a transparent lid (for 1U version)
- ▶ Including 6 large Fiber Optic Trays with a transparent lid (for 2U version)
- ▶ Removable Fiber Optic Trays to facilitate easy installation and maintenance
- ▶ Space for a fiber storage under the Fiber Optic Trays
- ▶ Optional Splice Holders (heat-shrink, crimp, ribbon, etc.)
- ▶ Available lower density



UHD ORMP 1U



UHD ORMP 2U



UHD ORMP 1U
144LC (removed trays)

TECHNICAL SPECIFICATIONS

Inputs / Outputs (quantity × range)	2 / 4 × 8–16 mm
Grommets (type and number of used grommets)	2 / 4 × PG16
Material	painted steel sheet (aluzinc)
Color	light gray RAL 7035
Dimensions (H × W × D)	44 / 88 × 483 × 349 mm
Weight	4.4 / 5.8 kg

ORDERING CODES

85L8.00/003XF	Ultra High Density Fiber Optic Patch Panel UHD ORMP 1U (incl. 3 Fiber Optic Trays)
85L8.00/004XF	Ultra High Density Fiber Optic Patch Panel UHD ORMP 2U (incl. 6 Fiber Optic Trays)

▶ For other variants, please, contact our sales department.

ORMP 1U, ORMP 2U

GPON READY 5G READY

BESTSELLER

The ORMP draw-out-type ODF is designed for the placement of 24/48/72 optical connectors indoors. The design of the patch panel enables to install it into a 19" rack.

- ▶ Capacity of 24–72 optical connectors
- ▶ Connector panel 12/24/48/72 SC simplex, E2000
- ▶ Needle holder of optical splice trays
- ▶ Placement of optical fiber reserve
- ▶ Self-adhesive cable rings
- ▶ Possibility to fit it with PG grommets
- ▶ Adjustable mounting brackets
- ▶ Easy assembly
- ▶ Installation into a 19" base
- ▶ Height of 1U/2U



ORMP 1U



ORMP 2U



TECHNICAL SPECIFICATIONS

	ORMP 1U	ORMP 2U
Inputs / Outputs (quantity × range)	2 × 8–16 mm	2 × 8–16 mm, 2 × 5–8.5 mm
Grommets (type and number of used grommets)	2 × PG16	2 × PG16, 2 × PG9
Temperature Range	–40 °C / +70 °C	–40 °C / +70 °C
Material	painted steel sheet	painted steel sheet
Color	black RAL 9005	black RAL 9005
Dimensions (H × W × D)	44 × 483 × 250 mm	88 × 483 × 250 mm
Weight	3.4 kg	4.3 kg

ORDERING CODES ORMP 1U

85HS.00/BK05F	ORMP 1U 12 × SC/E2000
85HS.05/BK05F	ORMP 1U 24 × SC/E2000

ORDERING CODES ORMP 2U

85HS.09/BK05F	ORMP 2U 48 × SC/E2000
85HS.10/BK05F	ORMP 2U 72 × SC/E2000

- ▶ For other variants, please, contact our sales department.

ORMPV 1U, ORMPV 2U, ORMPV 3U

GPON READY **5G READY**

The ORMPV hinged module patch panel is designed for placing 48/96/288 connectors indoor. The design of the distributor enables installation on a 19" rack.

- ▶ Capacity of up to 48/96/288 connectors
- ▶ Connector holder SC simplex, ST, FC, E2000, LC, SC duplex
- ▶ Optical splice tray holder
- ▶ Placement of optical fiber reserve
- ▶ Self-adhesive cable rings
- ▶ Easy assembly
- ▶ Installation into a 19" base
- ▶ Possibility of rear fastening
- ▶ Side depth adjustable 19" mounting kit
- ▶ Height of 1U/2U
- ▶ Cable entrance from the back or the side



ORMPV 2U
BESTSELLER



ORMPV 1U

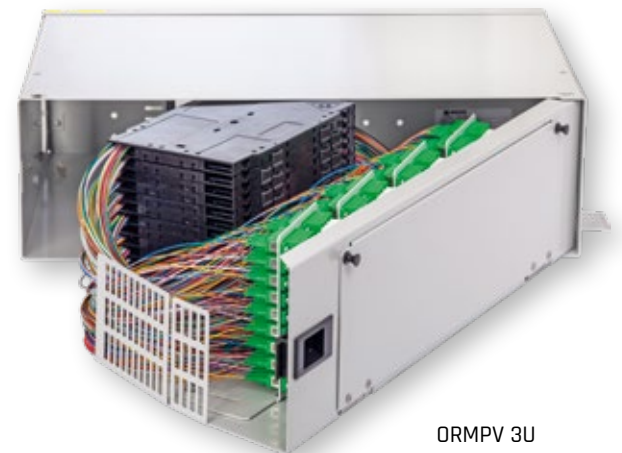

ORMPV 3U

ORDERING CODES ORMPV 1U

8505.80/0AZCF	Without adapter panel and trays
8505.07/000CF	Panel 24× E2000
8505.09/000CF	Panel 36× E2000
8505.12/000CF	Panel 12× E2000
8505.65/000CF	Panel 12× SC DUPLEX/QUADPLEX
8563.52/000CF	Panel 24× SC
8563.53/000CF	Panel 36× SC
8563.54/000CF	Panel 12× SC
8505.16/000CF	Panel 24× SC DUPLEX
8505.29/000CF	Panel 24× ST/FC

▶ For other variants, please, contact our sales department.

ORDERING CODES ORMPV 2U

8563.00/0AZCF	Without adapter panel and trays
8505.15/000CF	Panel 72× E2000
8505.27/000CF	Panel 48× E2000
8505.28/000CF	Panel 48× ST/FC
8563.51/000CF	Panel 48× SC
8563.57/000CF	Panel 72× SC
8505.56/000CF	Panel 96× SC
8505.57/000CF	Panel 96× E2000
8505.84/0000F	Set – 8× Splice tray SK120

▶ For other variants, please, contact our sales department.

ORDERING CODES ORMPV 3U

85HU.85/00BKF	Without adapter panel and trays
85hu.95/000CF	Panel 144× E2000/SC
8563.69/00AC	Panel 72× LCQ right
8523.45/1200F	Set 12× Fiber Optic Tray KM 1
85H4.07/1212F	Set 12× Fiber Optic Tray EC2

▶ For other variants, please, contact our sales department.

Adjustable mounting kit



TECHNICAL SPECIFICATIONS

	ORMPV 1U	ORMPV 2U	ORMPV 3U
Material	painted steel sheet (aluzinc)	painted steel sheet (aluzinc)	painted steel sheet (aluzinc)
Color	light gray RAL 7035	light gray RAL 7035	light gray RAL 7035
Dimensions (H × W × D)	43 × 436 × 280 mm	88 × 436 × 282 mm	132 × 465 × 269 mm
Weight	4 kg	4.6 kg	7 kg

ORMPM 3U/144

The module rackmounted distributor ORMPM 3U/144 is designed for the placement 144 optical connectors into 12 vertical modules indoor. It is to install into 19" rack.

- ▶ Capacity 144 optical connectors
- ▶ Connector holder SC simplex, E2000
- ▶ 12 vertically placed modules
- ▶ Placement of optical fiber reserve
- ▶ Installation into a 19" frame
- ▶ High 3U
- ▶ possibility of installing the both the front and the rear support rails
- ▶ Possibility of horizontal sliding



ORMPM 3U/144

Module 12x SC

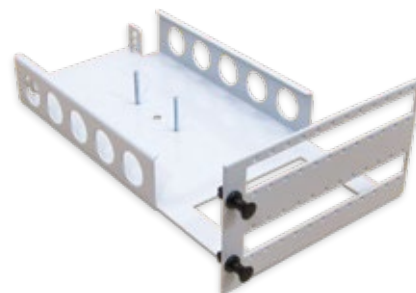

Module 24x SC

TECHNICAL SPECIFICATIONS

Material	painted steel sheet
Color	light gray RAL 7035
Dimensions (H x W x D)	130 x 483 x 250 mm
Weight	3.2 kg

ORDERING CODES

8562.00/0000F	ORMPM 3U/144 ORMPM 3U/144 (fixed mounting kit)
8562.10/SC00F	Module 12x SC
85R6.00/0000F	ORMPM 3U/144 PL (adjustable mounting kit)

- ▶ For other variants, please, contact our sales department.

ACCESSORIES FOR ORMPM



ORDERING CODES

		Position
8562.25/0000F	Box for reserves 1U	-
8562.15/0000F	Box for reserves 2U	1
8562.34/0000F	Box for reserves – rear entry without rings	2
8562.80/0000F	Box for reserves – rear entry with cable rings	3

► For other variants, please, contact our sales department.

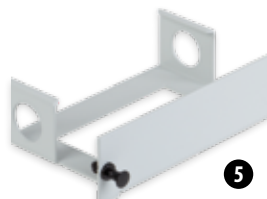
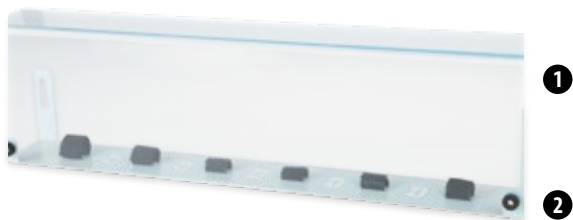

ORDERING CODES

		Position
8562.18/PLEXF	Plexi for ranging panel	1
8562.18/PAN0F	Ranging panel	2
8562.18/0000F	Ranging panel with plexi	1+2
8562.11/0000F	Cable lead panel ORMPM 3U	3
8562.38/000CF	Blinding panel	4
8562.39/000CF	Blinding modul	5
491582	Corrugated tube 4.8 × 7.1 mm	6

► For other variants, please, contact our sales department.

MDO 300



The Fiber High Density Cabinet MDO 300 is used to store up to 1,728 splices and to terminate up to 576 fibers with SC connectors or 1,152 fibers with LC connectors using the FibeRoad™ System. It is a modular solution without cable splitters and without drawing into protective tubes, with a uniform patch cord length of 4 m. The cabinet can be used in central office and for all types of networks.

- ▶ Capacity of up to 1,728 splices (for KM 4)
- ▶ Capacity of up to 432× SC / 864× LC connector (for KM 5 without the ranging management)
- ▶ Capacity of up to 576× SC / 1,152× LC connector (for KM 7 without the ranging management)
- ▶ Ability to assemble only the Subrack part or the ranging management
- ▶ Ability to mix & match the Fiber Optic Trays KM 4, KM 5, KM 6, KM 7
- ▶ KM 4 and KM 6 for up to 24 splices
- ▶ KM 5 for up to 12× SC / 24× LC connector
- ▶ KM 7 for up to 8× SC / 16× LC connector (for GPON)
- ▶ Uniform patch cord length of 4 m
- ▶ Ability to gradually add trays as required
- ▶ Modular solution without cable splitter functionality
- ▶ Optional placing of PLC Splitters (outside a tray)
- ▶ Ability to stack the cabinets sideways or back to back
- ▶ Roof mounted cable tray and access
- ▶ Increased corrosion resistance (aluzinc)
- ▶ FibeRoad™ System compatible
- ▶ Suitable for ribbon fibers
- ▶ Suitable for all types of networks

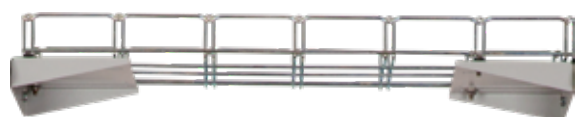
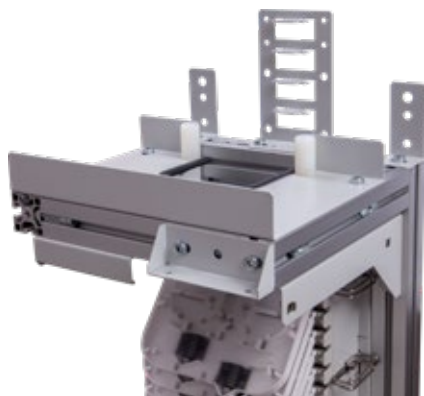

MDO Grate Holder

TECHNICAL SPECIFICATIONS

Inputs / Outputs (quantity × range)	2× (230 × 55) mm
Material	painted steel sheet (aluzinc)
Color	light gray RAL 7035
Dimensions (H × W × D)	2,200 × 300 × 300 mm
Flat Pack Dimensions (H × W × D)	2,350 × 303 × 85 mm
Flat Pack Weight	28 kg

ORDERING CODES

85U5.90/0000F	MDO 300 432/864 (flat pack)
85U5.20/0000F	MDO Subrack
85U5.60/0000F	MDO Side Cover (2 pcs)
85U5.95/0000F	MDO Door 300
85U5.94/0000F	MDO Grate Holder (assembly)
85C3.79/000X	KM 4 Kit for Heat Shrinkable Protection
85C3.83/000X	KM 6 Kit for Heat Shrinkable Protection
85AV.94/0000F	KM 5 Kit for Heat Shrinkable Protection
85C3.86/000X	KM 7 Kit for Heat Shrinkable Protection

▶ For other variants, please, contact our sales department.



KM 4

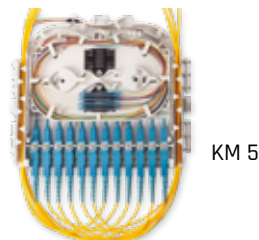

KM 5



KM 6

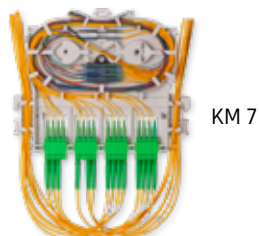

KM 7



MDO 600



The Fiber High Density Cabinet MDO 600 is used to store up to 1,728 splices and to terminate up to 576 fibers with SC connectors or 1,152 fibers with LC connectors using the FibeRoad™ System. It is a modular solution without cable splitters and without drawing into protective tubes, with a uniform patch cord length of 4 m. The cabinet can be used in central office and for all types of networks.

- ▶ Capacity of up to 1,728 splices (for KM 4)
- ▶ Capacity of up to 432× SC / 864× LC connector (for KM 5)
- ▶ Capacity of up to 576× SC / 1,152× LC connector (for KM 7)
- ▶ Ability to mix & match the Fiber Optic Trays KM 4, KM 5, KM 6, KM 7
- ▶ KM 4 and KM 6 for up to 24 splices
- ▶ KM 5 for up to 12× SC / 24× LC connector
- ▶ KM 7 for up to 8× SC / 16× LC connector (for GPON)
- ▶ Uniform patch cord length of 4 m
- ▶ Ability to gradually add trays as required
- ▶ Modular solution without cable splitter functionality
- ▶ Optional placing of PLC Splitters (outside a tray)
- ▶ Up to 9 PLC Splitters ABS (length 4 m)
- ▶ Ability to stack the cabinets sideways or back to back
- ▶ Roof mounted cable tray and access
- ▶ Increased corrosion resistance (aluzinc)
- ▶ FibeRoad™ System compatible
- ▶ Suitable for ribbon fibers
- ▶ Suitable for all types of networks



MDO Grate Holder

TECHNICAL SPECIFICATIONS

Inputs / Outputs (quantity × range)	2× (230 × 55) mm
Material	painted steel sheet (aluzinc)
Color	light gray RAL 7035
Dimensions (H × W × D)	2,200 × 600 × 300 mm
Flat Pack Dimensions (H × W × D)	2,350 × 603 × 85 mm
Flat Pack Weight	37 kg

ORDERING CODES

85U5.80/0000F	MDO 600 432/864 (flat pack)
85U5.20/0000F	MDO Subrack
85U5.58/0000F	MDO Splitter Box
85U5.60/0000F	MDO Side Cover (2 pcs)
85U5.85/0000F	MDO Door 600
85U5.94/0000F	MDO Grate Holder (assembly)
85C3.79/0000X	KM 4 Kit for Heat Shrinkable Protection
85C3.83/0000X	KM 6 Kit for Heat Shrinkable Protection
85AV.94/0000F	KM 5 Kit for Heat Shrinkable Protection
85C3.86/0000X	KM 7 Kit for Heat Shrinkable Protection

▶ For other variants, please, contact our sales department.



KM 4

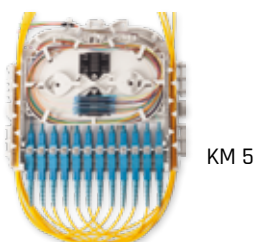

KM 5



KM 6

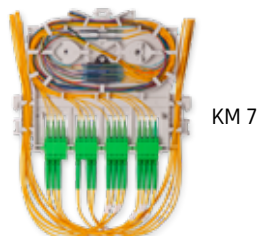

KM 7



MDO 900

NEW **GPON READY** **5G READY** **FibeRoad**

The Fiber High Density Cabinet MDO 900 is used to store up to 3,456 splices and to terminate up to 1,152 fibers with SC connectors or 2,304 fibers with LC connectors using the FibeRoad™ System. It is a modular solution without cable splitters and without drawing into protective tubes, with a uniform patch cord length of 4 m. The cabinet can be used in central office and for all types of networks.

- ▶ Capacity of up to 3,456 splices (for KM 4)
- ▶ Capacity of up to 864× SC / 1,728× LC connector (for KM 5)
- ▶ Capacity of up to 1,152× SC / 2,304× LC connector (for KM 7)
- ▶ Ability to mix & match the Fiber Optic Trays KM 4, KM 5, KM 6, KM 7
- ▶ KM 4 and KM 6 for up to 24 splices
- ▶ KM 5 for up to 12× SC / 24× LC connector
- ▶ KM 7 for up to 8× SC / 16× LC connector (for GPON)
- ▶ Uniform patch cord length of 4 m
- ▶ Ability to gradually add trays as required
- ▶ Modular solution without cable splitter functionality
- ▶ Optional placing of PLC Splitters (outside a tray)
- ▶ Up to 9 PLC Splitters ABS (length 4 m)
- ▶ Ability to stack the cabinets sideways or back to back
- ▶ Roof mounted cable tray and access
- ▶ Increased corrosion resistance (aluzinc)
- ▶ FibeRoad™ System compatible
- ▶ Suitable for ribbon fibers
- ▶ Suitable for all types of networks

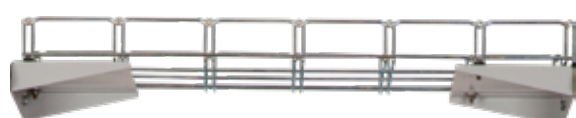
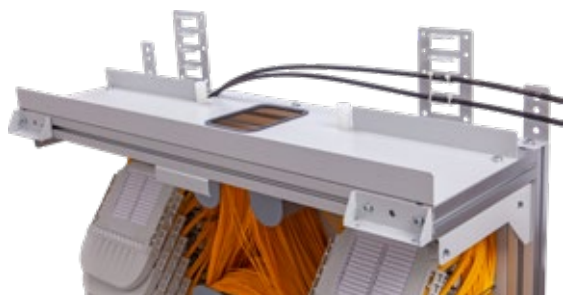

MDO Grate Holder

TECHNICAL SPECIFICATIONS

Inputs / Outputs (quantity × range)	4× (230 × 55) mm
Material	painted steel sheet (aluzinc)
Color	light gray RAL 7035
Dimensions (H × W × D)	2,200 × 900 × 300 mm
Flat Pack Dimensions (H × W × D)	2,350 × 903 × 85 mm
Flat Pack Weight	47 kg

ORDERING CODES

85U5.70/0000F	MDO 900 864/1728 (flat pack)
85U5.20/0000F	MDO Subrack
85U5.58/0000F	MDO Splitter Box
85U5.60/0000F	MDO Side Cover (2 pcs)
85U5.75/0000F	MDO Door 900
85U5.94/0000F	MDO Grate Holder (assembly)
85C3.79/000X	KM 4 Kit for Heat Shrinkable Protection
85C3.83/000X	KM 6 Kit for Heat Shrinkable Protection
85AV.94/0000F	KM 5 Kit for Heat Shrinkable Protection
85C3.86/000X	KM 7 Kit for Heat Shrinkable Protection

▶ For other variants, please, contact our sales department.

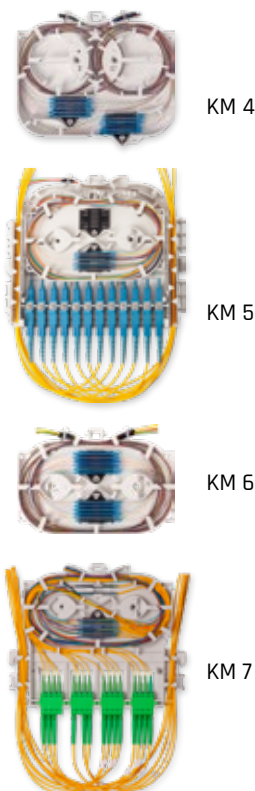

KM 4

KM 5

KM 6

KM 7



YouTube



MDO Subrack

NEW **GPON READY** **5G READY** **FiberRoad**

The Subrack for Fiber High Density Cabinets MDO is used to store up to 864 splices and to terminate up to 288 fibers with SC connectors or 576 fibers with LC connectors using the FiberRoad™ System. It is a modular solution with a tilt-out system without cable splitters and without drawing into protective tubes.

- ▶ Capacity of up to 864 splices (for KM 4)
- ▶ Capacity of up to 216× SC / 432× LC connector (for KM 5)
- ▶ Capacity of up to 288× SC / 576× LC connector (for KM 7)
- ▶ Ability to mix & match the Fiber Optic Trays KM 4, KM 5, KM 6, KM 7
- ▶ KM 4 and KM 6 for up to 24 splices
- ▶ KM 5 for up to 12× SC / 24× LC connector
- ▶ KM 7 for up to 8× SC / 16× LC connector (for GPON)
- ▶ Ability to gradually add trays as required
- ▶ Modular solution without cable splitter functionality
- ▶ Optional placing of PLC Splitters (outside a tray)
- ▶ Increased corrosion resistance (aluzinc)
- ▶ FiberRoad™ System compatible
- ▶ Suitable for ribbon fibers
- ▶ Suitable for all types of networks

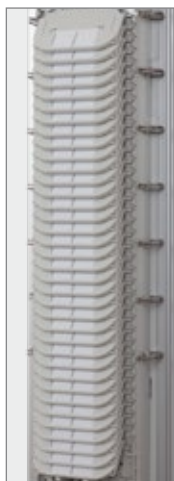
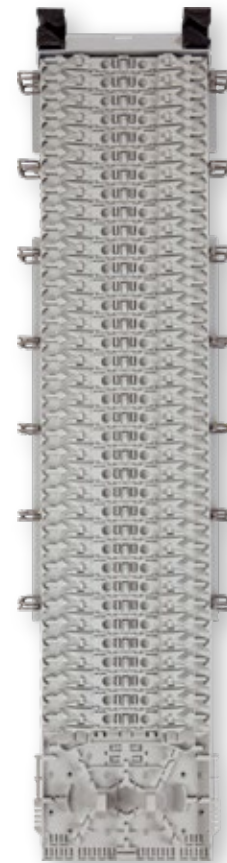

36× KM 6

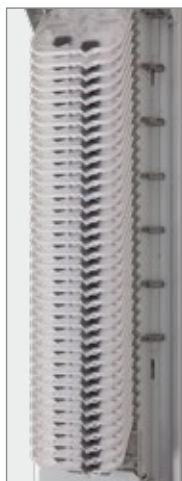

36× KM 4

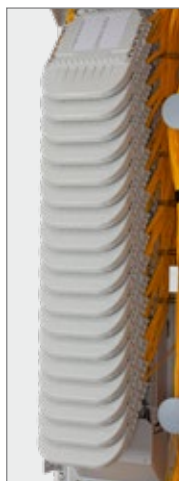

18× KM 5



36× KM 7



Tray Combination



TECHNICAL SPECIFICATIONS

Inputs / Outputs (quantity × range)	1× (230 × 55) mm
Material	painted steel sheet (aluzinc)
Color	light gray RAL 7035
Dimensions (H × W × D)	953 × 240 × 101 mm
Flat Pack Weight	4.5 kg

ORDERING CODES

85U5.20/0000F	MDO Subrack
85U5.70/0000F	MDO 900 864/1728 (flat pack)
85U5.80/0000F	MDO 600 432/864 (flat pack)
85U5.90/0000F	MDO 300 432/864 (flat pack)
85C3.79/000X	KM 4 Kit for Heat Shrinkable Protection
85C3.82/000X	KM 4 Kit for Crimp Protection
85C3.81/000X	KM 4 Kit for Ribbon Protection
85AV.94/0000F	KM 5 Kit for Heat Shrinkable Protection
85AV.94/00K2F	KM 5 Kit for Crimp Protection
85AV.94/00R3F	KM 5 Kit for Ribbon Protection
85C3.83/000X	KM 6 Kit for Heat Shrinkable Protection
85C3.85/000X	KM 6 Kit for Crimp Protection
85C3.84/000X	KM 6 Kit for Ribbon Protection
85C3.86/000X	KM 7 Kit for Heat Shrinkable Protection
85C3.88/000X	KM 7 Kit for Crimp Protection
85C3.87/000X	KM 7 Kit for Ribbon Protection

▶ For other variants, please, contact our sales department.

ORSL EE

GPON READY 5G READY

The high-capacity stand distribution cabinet is designed for the installation of 19" technology indoors. There is space for the placement of the optical interconnected patchcords reserve on the right side. The distribution cabinet is designed for the assembly of 19" optical distribution panels and for the installation of active components only on rear 19" rails.

- ▶ Height 44U
- ▶ Easy module system
- ▶ Cable inputs from bottom or from top
- ▶ Easy access to cables and fibers
- ▶ Option to terminate all the types of cables and micro ducts
- ▶ Horizontal and vertical organization of patchcords
- ▶ Easy assembly
- ▶ Possibility of right or left version
- ▶ Flat pack

TECHNICAL SPECIFICATIONS

Grommets (type and number of used grommets)	cable inlet
Material	painted steel sheet (aluzinc)
Color	light gray RAL 7035
Dimensions (H x W x D)	2,200 x 1,050 x 300 mm
Weight	90 kg

ORDERING CODES

85GM.50/0000F	ORSL EE basic module
85GM.51/0000F	ORSL EE module 300
85GM.52/0000F	ORSL EE module 150
85GM.53/0000F	ORSL EE door + module cover 300
85GM.54/0000F	ORSL EE door + module cover 150
85GM.55/0000F	ORSL EE door + basic module cover
85GM.56/0000F	ORSL EE set of reels 7pcs
85GM.57/0000F	ORSL EE cable holder
85GM.60/0000F	ORSL EE roof cover and bottom cover 150
85GM.61/0000F	ORSL EE roof cover and bottom cover 300
85GM.62/0000F	ORSL EE roof cover and bottom cover 600
85GM.63/0000F	ORSL EE lock-door + module cover 300
85GM.64/0000F	ORSL EE lock-door + module cover 150
85GM.65/0000F	ORSL EE lock-door + basic module cover

▶ For other variants, please, contact our sales department.



Cable holder



Adjustable feet

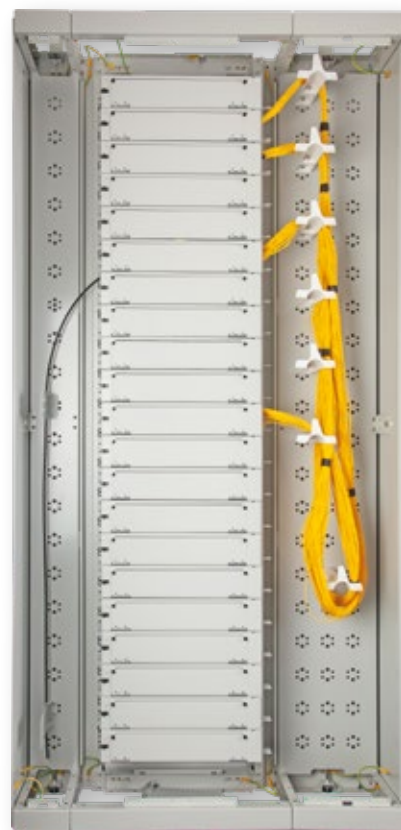

Without door



ORMPV 1U

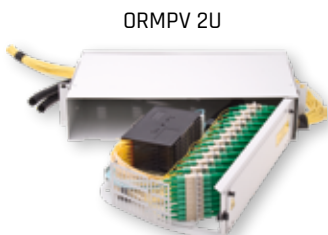

ORMPV 2U



ORMPV 3U

ORSL AP 300, ORSL AP 600

GPON READY **5G READY**

The high-capacity stand distribution cabinet is designed for the installation of 19" technology outdoors. There is prepare the space for the placement of the optical interconnected patchcords reserve on the right. Distribution cabinet is designed for the assembly of 19" optical distribution boxes and for the installation of active components.

- ▶ Height 42U
- ▶ Easy module system
- ▶ Cable inputs from bottom or from top
- ▶ Easy access to cables and fibers
- ▶ Option to terminate all the types of cables and micro ducts
- ▶ Horizontal and vertical organization of patchcords
- ▶ Easy assembly
- ▶ Extensive accessories
- ▶ Optional final finish
- ▶ Possibility of right or left version



ORSL AP 300



ORMPV 1U



ORMPV 2U



ORMPV 3U



TECHNICAL SPECIFICATIONS

	ORSL AP 300	ORSL AP 600
Inputs / Outputs (quantity × range)	4× brush inlet (220 × 60) mm, 2× brush inlet (160 × 60) mm	2× brush inlet (300 × 60) mm, 4× brush inlet (220 × 60) mm
Grommets (type and number of used grommets)	6× brush inlet	6× brush inlet
Material	painted steel sheet	painted steel sheet
Color	light gray RAL 7035	light gray RAL 7035
Dimensions (H × W × D)	2,165 × 900 × 300 mm	2,000 × 900 × 600 mm
Weight	15 kg	25 kg

ORDERING CODES

85NE.00/0000F	ORSL AP 300
85K6.00/0000F	ORSL AP 600

- ▶ For other variants, please, contact our sales department.

FibeRoad™ System - The Best Solution for FTTx

FibeRoad

At Micos Telcom, we've created the best splice management solution for your fiber network, whether it's GPON or 5G. Using the FibeRoad™ System across all points of your network (from small closures to large cabinets) will make deployment and maintenance a routine rather than challenge for your technicians.

- ▶ Variable capacity: ability to gradually add trays as required
- ▶ Accesable stacking system
- ▶ Significant space savings through a cascading tray solution
- ▶ Ability to mix & match the Fiber Optic Trays KM 4, KM 5, KM 6, KM 7
- ▶ Initiative patching solution embeded and inclusive with the stacking system
- ▶ Optional placing of PLC Splitters (outside a tray)
- ▶ Extended space for fiber reserves
- ▶ Ability to place fibers in a secondary sheath (pigtail, ø 0.9 mm)
- ▶ Suitable for all types of networks
- ▶ Suitable for ribbon fibers

ORDERING CODES

		Position
495529	Management KM P	1
495785	Support Stick (2 pcs needed)	2
495530	Tray Holder KM	3

▶ For other variants, please, contact our sales department.



FibeRoad™ System

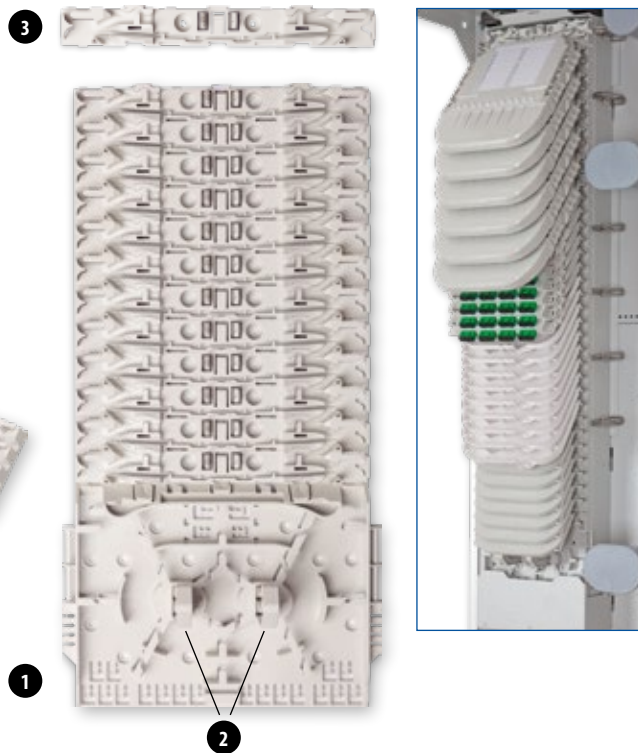

KM 4

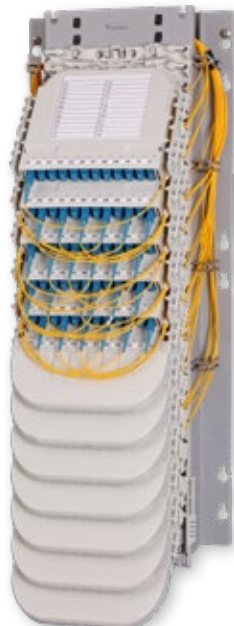

KM 5



KM 6

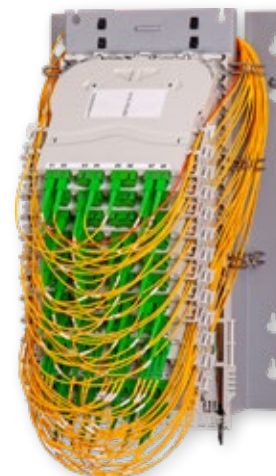

KM 7

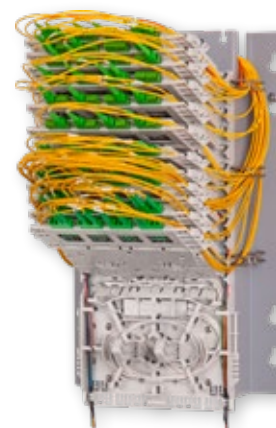

KM 4

BESTSELLER **GPON READY** **5G READY** **FibeRoad**

The Fiber Optic Tray KM 4 is designed for up to 24 fibers. It can be used separately mounted on an existing mandrel or in conjunction with the FibeRoad™ System. It is compatible with all types of fibers and is very intuitive to use. A full range of Splice Holders is available to ensure compatibility.

- ▶ Capacity of up to 24 splices
- ▶ PLC Splitter capability (small format)
- ▶ FibeRoad™ System compatible
- ▶ Hinged or stackable mounting
- ▶ No need to measure fibers before splicing
- ▶ Heat shrink splice protector segregation feature
- ▶ Ability to store feeder and drop fibers separately
- ▶ Ability to change direction of the fiber storage
- ▶ Ability to place fibers in a secondary sheath (pigtail, ø 0.9 mm)
- ▶ Suitable for ribbon fibers



KM 4 (24 splices)

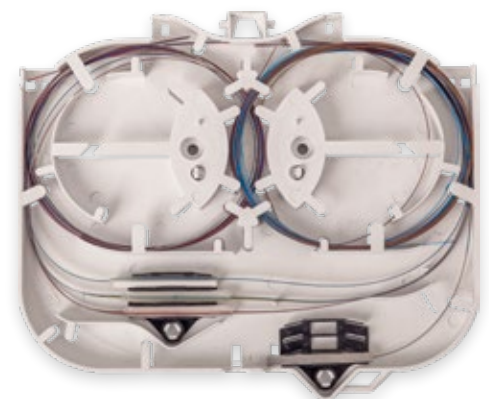

KM 4 (3x ribbon + splitter)

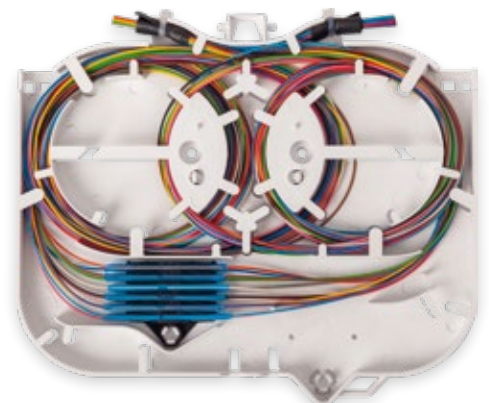

KM 4 (12 splices, fibers in a secondary sheath)

TECHNICAL SPECIFICATIONS

Flammability Degree	V0
Material	PC / ABS
Color	light gray RAL 7035
Dimensions (H x W x D)	12 x 175 x 149 mm
Weight	0.1 kg

ORDERING CODES

85C3.79/000X	KM 4 Kit for Heat Shrinkable Protection
85C3.82/000X	KM 4 Kit for Crimp Protection
85C3.81/000X	KM 4 Kit for Ribbon Protection
493520	Heat Shrink Splice Protector (compatible with TS 12, 45 x 2.4 mm)

- ▶ For other variants, please, contact our sales department.



Splice Holder TS 12
(for heat shrink splices)



Splice Holder K 12
(for crimp splices)



Splice Holder RIB 3
(3x ribbon or splitter 4 x 4 mm)

KM 5

NEW **GPON READY** **5G READY** **FibeRoad**

The Fiber Optic Tray KM 5 is designed to support up to 24 optical fibers and connectors. Fibers are terminated with pigtails to 12× SC or 24× LC connector – with additional PLC Splitter capability. Splices are housed within the internal Fiber Optic Tray KM 6. This allows for placing various types of Splice Holders. It is compatible with all types of fibers and is very intuitive to use. It can be used separately or in conjunction with the FibeRoad™ System.

- ▶ Capacity of up to 24 splices
- ▶ Capacity of up to 12× SC / 24× LC connector
- ▶ PLC Splitter capability (small format)
- ▶ FibeRoad™ System compatible
- ▶ Hinged or stackable mounting
- ▶ Reserve space for cable slack in the bottom part of the tray
- ▶ Built-in patch cord management
- ▶ Patch cord cover
- ▶ Ability to change direction of the fiber storage
- ▶ Ability to place fibers in a secondary sheath (pigtail, ø 0.9 mm)
- ▶ Suitable for ribbon fibers

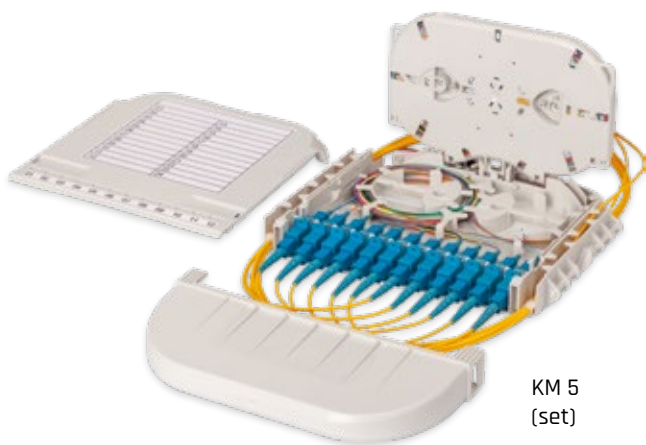
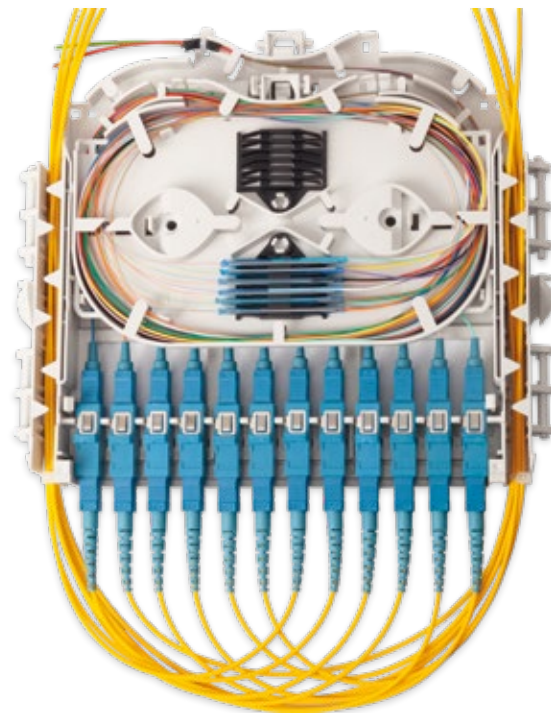

KM 5 (set)



KM 5 (the FibeRoad™ System - cascade solution)



2× KM 5 (connected by a connecting piece)

TECHNICAL SPECIFICATIONS

Flammability Degree	V0
Material	PC / ABS
Color	light gray RAL 7035
Dimensions (H × W × D)	26 × 205 × 179 mm
Weight	0.2 kg

ORDERING CODES

85AV.94/0000F	KM 5 Kit for Heat Shrinkable Protection
85AV.94/00K2F	KM 5 Kit for Crimp Protection
85AV.94/00R3F	KM 5 Kit for Ribbon Protection
85C3.76/000X	KM 5 Kit for Heat Shrinkable Protection (for MDB boxes)
85C3.78/000X	KM 5 Kit for Crimp Protection (for MDB boxes)
85C3.77/000X	KM 5 Kit for Ribbon Protection (for MDB boxes)
493520	Heat Shrink Splice Protector (compatible with TS 12, 45 × 2.4 mm)

▶ For other variants, please, contact our sales department.

KM 6

GPON READY 5G READY FibeRoad

The Fiber Optic Tray KM 6 is designed for up to 24 fibers. It can be used separately mounted on an existing mandrel or in conjunction with the FibeRoad™ System. It is compatible with all types of fibers. A full range of Splice Holders is available to ensure compatibility.

- ▶ Capacity of up to 24 splices
- ▶ PLC Splitter capability (small format)
- ▶ FibeRoad™ System compatible
- ▶ Hinged or stackable mounting
- ▶ Ability to change direction of the fiber storage
- ▶ Ability to place fibers in a secondary sheath (pigtail, ø 0.9 mm)
- ▶ Suitable for ribbon fibers

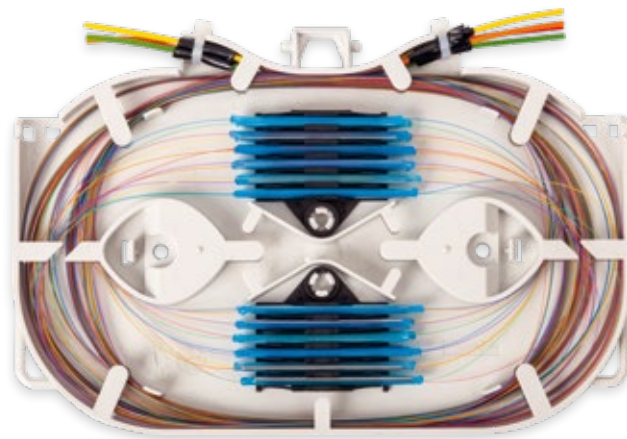

KM 6 (24 splices, fibers in a secondary sheath)



KM 6 (with a lid and sticker)



Splice Holder TS 12
(for heat shrink splices)



Splice Holder K 12
(for crimp splices)



Splice Holder RIB 3
(3x ribbon or splitter 4 x 4 mm)

TECHNICAL SPECIFICATIONS

Flammability Degree	V0
Material	PC / ABS
Color	light gray RAL 7035
Dimensions (H x W x D)	10 x 160 x 106 mm
Weight	0.1 kg

ORDERING CODES

85C3.83/000X	KM 6 Kit for Heat Shrinkable Protection
85C3.85/000X	KM 6 Kit for Crimp Protection
85C3.84/000X	KM 6 Kit for Ribbon Protection
493520	Heat Shrink Splice Protector (compatible with TS 12, 45 x 2.4 mm)

▶ For other variants, please, contact our sales department.

KM 7

NEW **GPON READY** **5G READY** **FibeRoad**

The Fiber Optic Tray KM 7 is designed to hold up to 16 optical fibers and connectors. Fibers are terminated with pigtails to 8× SC or 16× LC connector – with additional PLC Splitter capacity. The tray has a built-in holder for 4 splices and also allows for placing various types of Splice Holders. It is compatible with all types of fibers and is very intuitive to use. It can be used separately or in conjunction with the FibeRoad™ System.

- ▶ Capacity of up to 16 splices (a built-in holder for 4 splices)
- ▶ Capacity of up to 8× SC / 16× LC connector
- ▶ PLC Splitter capability (small format)
- ▶ FibeRoad™ System compatible
- ▶ Hinged or stackable mounting
- ▶ Built-in patch cord management
- ▶ Ability to change direction of the fiber storage
- ▶ Ability to place fibers in a secondary sheath (pigtail, ø 0.9 mm)
- ▶ Suitable for ribbon fibers

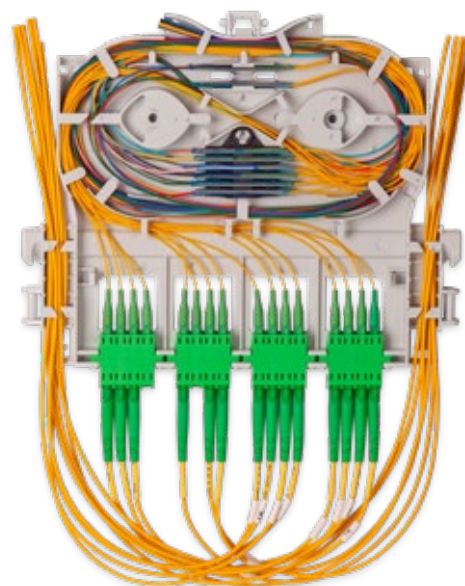

KM 7 (16× LC)

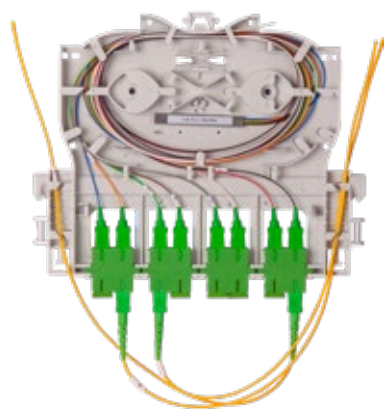

KM 7 (splitter 1:8)

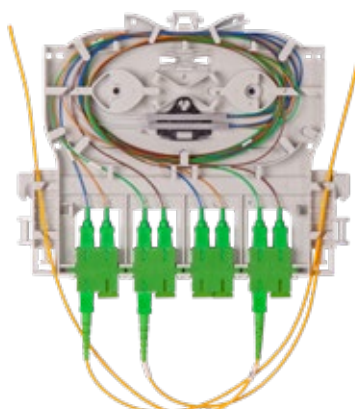

KM 7 (2× splitter 1:4)

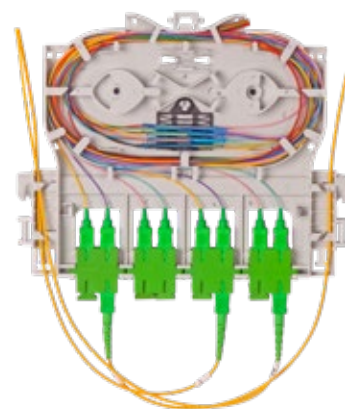

KM 7 (8× SC)

TECHNICAL SPECIFICATIONS

Flammability Degree	V0
Material	PC / ABS
Color	light gray RAL 7035
Dimensions (H × W × D)	12.9 × 165.8 × 205 mm
Weight	0.1 kg

ORDERING CODES

85C3.86/000X	KM 7 Kit for Heat Shrinkable Protection
85C3.88/000X	KM 7 Kit for Crimp Protection
85C3.87/000X	KM 7 Kit for Ribbon Protection
493520	Heat Shrink Splice Protector (compatible with TS 12, 45 × 2.4 mm)

- ▶ For other variants, please, contact our sales department.

SAFeTNET System

SAFeTNET



1



2



3

ORDERING CODES

		Position
50161047	Subscriber unit kit	1
50161004	Element unit kit	2
8506.59/0000F	SS splice trays module	3
8510.21/0000	SE, SC module lid	-

▶ For other variants, please, contact our sales department.

SFMS System

SFMS



1



3



5



7



2



4



6



8

ORDERING CODES

		Position
80811933	SC Short, 6F, Heat Shrinkable Protection	1
50161402	SC Short, 12F, Crimp Protection	2
80811935	SE Short, 12F, Heat Shrinkable Protection	3
80812916	SE Short, 4x Ribbon or 4x Splitter, Ribbon Protection	4
80812456	SC Long, 12F, Heat Shrinkable Protection	5
85100030	SC Long, 24F, Crimp Protection	6
50161971	SC Long, 24F + Splitter, Heat Shrinkable Protection	7
85100031	SC Long, 24F + Splitter, Crimp Protection	8

▶ For other variants, please, contact our sales department.

KM 1

- ▶ Placement of 12 splices
- ▶ Material – plastic
- ▶ The possibility of a packet assembly
- ▶ Recommended for distributor range ORM, ORMP, ORMPV, ORS, SNM, ORMPTR, SOP, POR, ORMPM

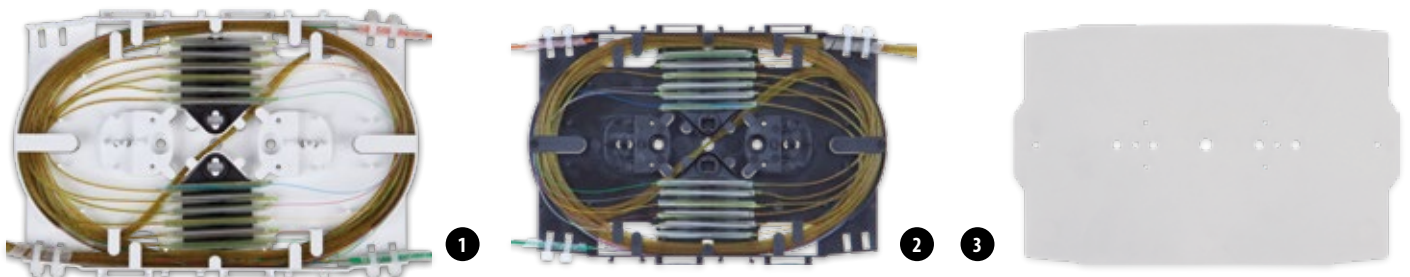

TECHNICAL SPECIFICATIONS

Flammability Degree	HB
Material	ABS
Color	black RAL 9005
Dimensions (H x W x D)	8 x 152 x 102 mm
Weight	0.1 kg

ORDERING CODES

Ordering Code	Description	Position
8510.12/0000	Lid for KM1	3
8523.40/0000	Splice tray KM1	2
8523.40/B000	KM 1 – white	1

▶ For other variants, please, contact our sales department.

KM 2

- ▶ Placement of up to 12 splices
- ▶ Material – plastic
- ▶ Recommended for distributor range ORM 4, ORM 8

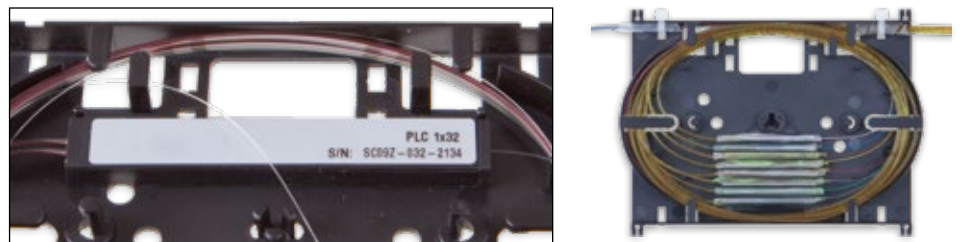

TECHNICAL SPECIFICATIONS

Flammability Degree	HB
Material	ABS
Color	black RAL 9005
Dimensions (H x W x D)	10 x 116 x 87 mm
Weight	0.1 kg

ORDERING CODES

8523.42/0000	KM 2 + lid
491303	TS 8 - 8 position splice holder (heatshrink)
85M9.16/0000	Splice Holder TS 12 (for heat shrink splices)

▶ For other variants, please, contact our sales department.

EC2

- ▶ Placement of 24 splices
- ▶ Material – plastic
- ▶ The possibility of a packet assembly
- ▶ Recommended for distributor range ORM 48

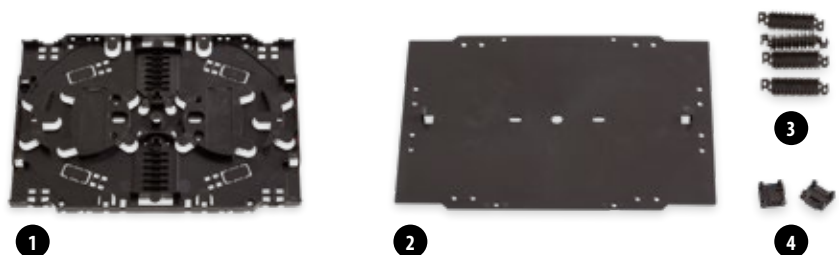

TECHNICAL SPECIFICATIONS

Color	black RAL 9005
Dimensions (H x W x D)	8 x 172 x 110 mm
Weight	0.1 kg

ORDERING CODES

Ordering Code	Description	Position
491711	Splice tray EC2	1
491712	Lid for splice tray EC2	2
492001	Splice comb for pigtails for splice tray EC2	3
491713	Hinge for splice tray EC2	4

▶ For other variants, please, contact our sales department.

Cable Splitter

The cable splitter is used to divide the optical fibres of one cable into several protection tubes of 6× ø 5 mm (No. 1), 24× ø 5 or 4 mm (No. 2), 8× 3 mm (No. 3).

- ▶ Maximum capacity of 288 fibers in cable
- ▶ Range of cables used ø 5.4–20 mm

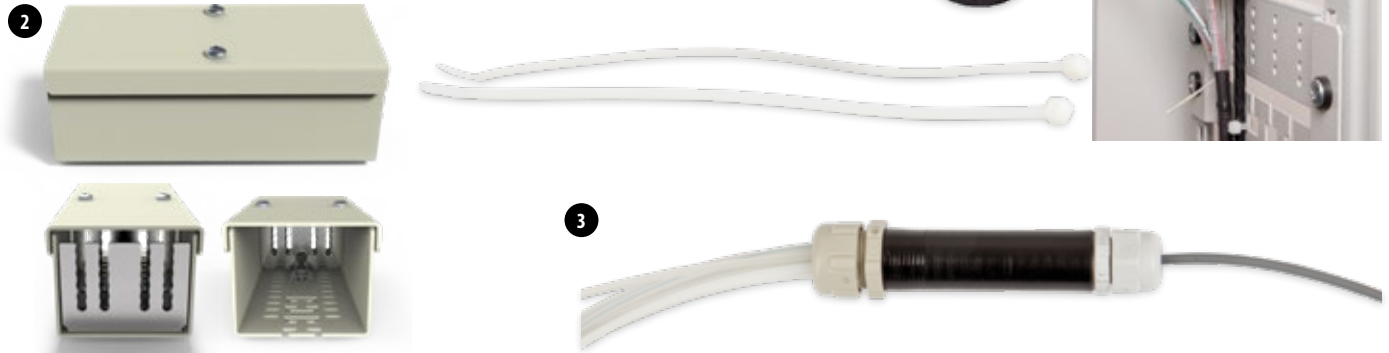

ORDERING CODES

		Position
85H2.05/BAL0F	Cable splitter 1:6	1
852X.60/0000F	Cable splitter 1:24	2
85FH.00/0000F	Cable splitter 1:8	3

- ▶ For other variants, please, contact our sales department.

PLC Splitter

The PLC Splitter splits one or two optical signals into multiple output ports and features low insertion loss, high uniformity and low polarization dependent loss.

- ▶ Compact design
- ▶ High Reliability
- ▶ Customized packing and configuration
- ▶ Available configuration: 1:2–1:64 and 2:4–2:64

Availability

- ▶ Bare fiber
- ▶ Fan-out
- ▶ 900 µm
- ▶ Pre-installed in splice tray
- ▶ Pre-installed in ODF or ODB



TECHNICAL SPECIFICATIONS

- Low insertion loss and low PDL
- Wide wavelength (1260 nm-1650 nm)
- Operation temperature (-40 °C to +85 °C)
- Fulfill Teclordia GR-1209-CORE and GR-11221-CORE

Patchcords and Fiber Optic Pigtails

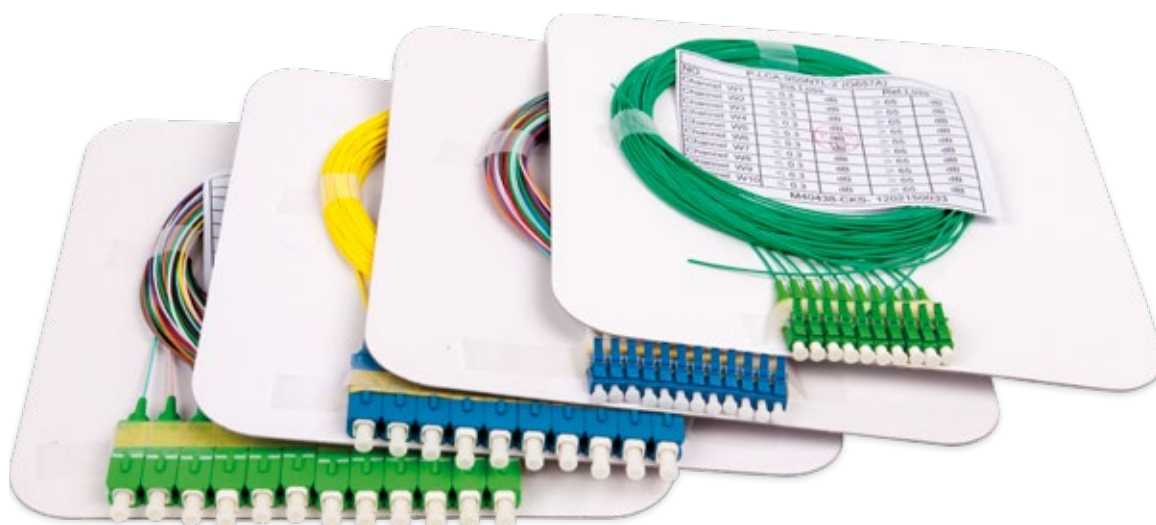

ORDERING CODES

CN0273 Pigtail set 12× LC/UPC, SM, G657A1 0.9 mm LSZH, 2 m (12-multi color set), easy strip

CN0032 Pigtail set 12× LC/APC, SM, G657A 0.9 mm LSZH, 2 m (12-multi color set), easy strip

CN0053 Pigtail set 12× SC/UPC, SM, G657A 0.9 mm LSZH, 2 m (12-multi color set), easy strip

CN0021 Pigtail set 12× SC/APC, SM, G657A 0.9 mm LSZH, 2 m (12-multi color set), easy strip

► For other variants, please, contact our sales department.

Optical Adapters

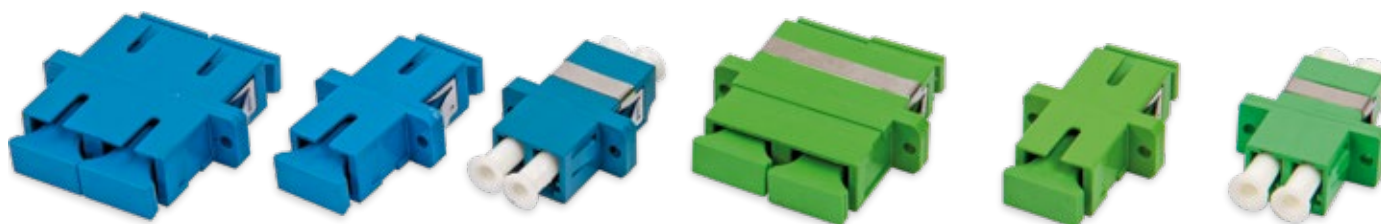

ORDERING CODES

CN0001 Adapter SC/UPC SM, SX, blue, metal clip

CN0003 Adapter SC/UPC SM, DX, blue, metal clip

CN0005 Adapter LC/UPC SM, DX, blue, with SC footprint, metal clip

CN0002 Adapter SC/APC SM, SX, green, metal clip

CN0004 Adapter SC/APC SM, DX, green, metal clip

CN0006 Adapter LC/APC SM, DX, green with SC footprint, metal clip

► For other variants, please, contact our sales department.

Splice Holders and Heatshrinks

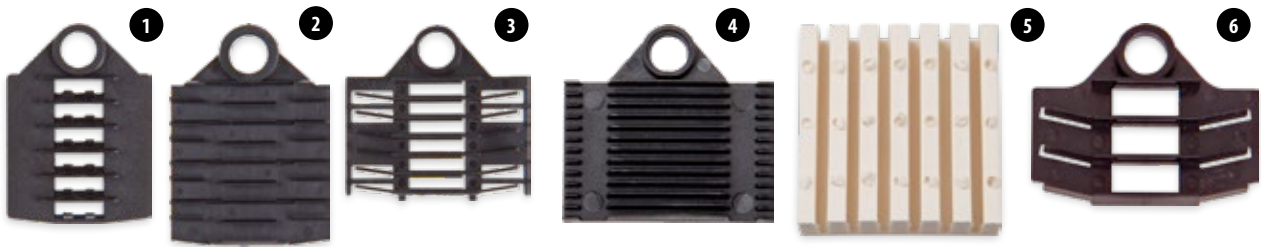

ORDERING CODES

		Position
491481	TS 6 – 6 position splice holder (heatshrink)	1
491303	TS 8 – 8 position splice holder (heatshrink)	2
85M9.16/0000	TS 12 – 12 position splice holder (heatshrink)	3
85M9.17/0000	K 12 – 12 position splice holder Crimp	4
8541.35/BALOF	CTS 12 – 37.5 × 40 × 8 mm - Rubber 12 position splice holder (heatshrink)	5
495241	RIB 3 – 3 position splice holder Ribbon or splitter 4 × 4 mm	6
493519	Heatshrink L=40mm D=2.4mm - compatible with TS 12	–
493520	Heatshrink L=45mm D=2.4mm - compatible with TS 12	–
493522	Heatshrink L=40mm D=2.6mm - compatible with TS 6 and TS 8	–
493523	Heatshrink L=45mm D=2.6mm - compatible with TS 6 and TS 8	–
493524	Heatshrink L=60mm D=2.6mm - compatible with TS 6 and TS 8	–

► For other variants, please, contact our sales department.

Splice Holders for SFMS Trays

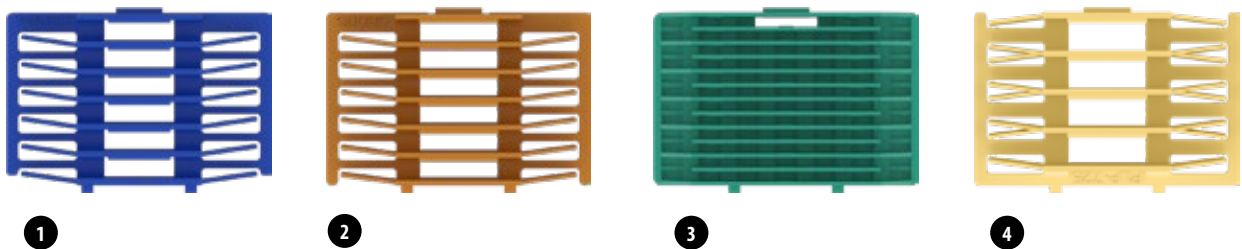

ORDERING CODES

		Position
80808004	Splice Block, 6F, Blue	1
80808005	Splice Block, 12F, Orange	2
80808018	Splice Block, 12F, Crimp, Green	3
80812439	Splice Block, 4, Ribbon, Mustard	4

► For other variants, please, contact our sales department.

Grommets



ORDERING CODES

		Position
85BV.25/0000F	PG 7	1
391900	PG 9	2
301000	PG 13.5	3
301100	PG 16	4
341000	PG 29	5

► For other variants, please, contact our sales department.



ORDERING CODES

		Position
85BV.25/0MVLF	PG 7 (3× 1.6–2.6 mm)	1
8580.67/0000F	PG 16 (2× 3 mm)	2
8580.68/0000F	PG 16 (4× 3 mm)	3
8580.66/0000F	PG 16 (4× 5 mm)	4
8560.23/1000F	PG 29 (12× 3 mm)	5
8523.30/0000F	PG 29 (24× 3 mm)	6

► For other variants, please, contact our sales department.

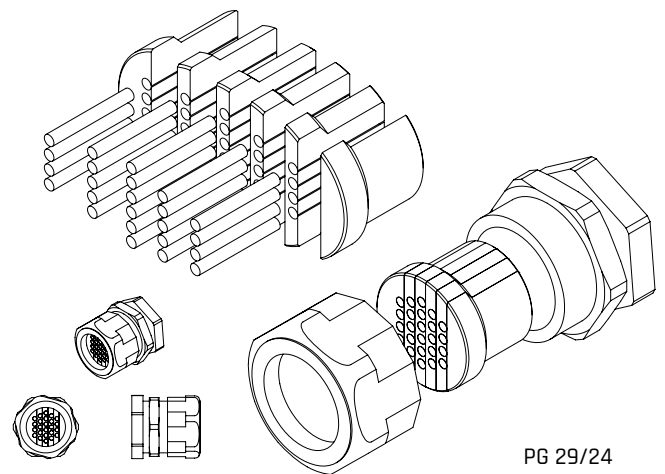

PG 29/24

Express Port

The Express Port for mid-span access allows optical cable installation into a box/cabinet as a loop and its use for only needed fibers – the rest passes through the box/cabinet.

- ▶ 1. Express port I. (2× 3–9 mm and 9× 1.8–5 mm)
- ▶ 2. Express port II. (2× 7–13 mm and 16× 2–5 mm or 8× 11–12 mm)

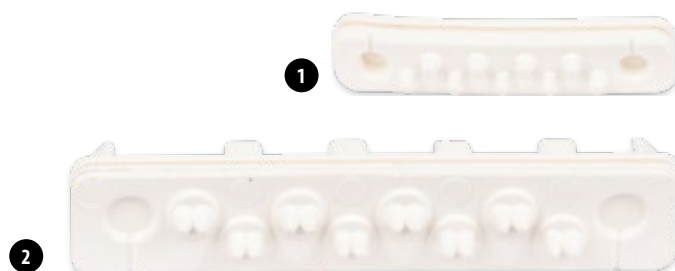

TECHNICAL SPECIFICATIONS

Material	onflex
Color	light gray RAL 7035
Dimensions (H × W × D)	19 × 89 × 15 mm
Weight	0.02 kg

ORDERING CODES

		Position
85K3.07/S000	Express port I.	1
85K3.99/0000	Express port II.	2

▶ For other variants, please, contact our sales department.

Ranging Rings and Protective Tubes



ORDERING CODES

		Position
8201.02/0300	Big ring	1
8201.01/0100	Small ring	2
490471	Plastic ring 40 × 80 mm	3
490550	Plastic ring 40 × 50 mm	4
490824	Plastic ring 80 × 80 mm	5
8506.12/0000F	Protective tube 3/2.1 mm, 50 m	6
8506.17/0000F	Protective tube 5/3.5 mm, 30 m	7

▶ For other variants, please, contact our sales department.

Fixing Material

ORDERING CODES

		Position
490360	Strap SCOTCHFLEX 20 mm × 10 m	1
492790	3M adhesive tape for the fibers fixation in optical splice tray	2
490543	Spiral tape 4 mm	3
490544	Spiral tape 6 mm	3

▶ For other variants, please, contact our sales department.



MNORS

The wall-mounted optical distribution cabinet MNORS is designed for the placement of 672 optical connectors indoors and outdoors.

- ▶ Capacity of 672 optical connectors
- ▶ Height 14U
- ▶ Possibility to install 19" hinged ODF ORMPV
- ▶ Easy access to cables and fibers
- ▶ E2000 or SC connector panel
- ▶ Easy module system
- ▶ Easy manipulation with connecting patchcords
- ▶ 2× two-point lock
- ▶ It enables to install active components
- ▶ Cable inputs/outputs from bottom or from top
- ▶ Recommended patchcord diameter 1.8 mm

TECHNICAL SPECIFICATIONS

Inputs / Outputs (quantity × range)	24× 8–12 mm
Grommets (type and number of used grommets)	24× PG13.5
Ingress Protection	IP54
Material	painted steel sheet
Color	light gray RAL 7035
Dimensions (H × W × D)	930 × 700 × 366 mm
Weight	39 kg

ORDERING CODES

85JN.40/ST00F	MNORS Indoor
85JN.20/ST00F	MNORS Outdoor

- ▶ For other variants, please, contact our sales department.



ORMPV 1U



ORMPV 2U



ORMPV 3U

MNS

The MNS wall mounted data cabinets are designed for the indoor installation of 19" technology onto a wall. Sliding supporting bars are used to install 19" technology.

- ▶ Base dimensions 550 × 570 mm
- ▶ Height 4U, 6U, 9U, 12U, 15U and 17U
- ▶ Lockable door
- ▶ Sliding bars for fastening 19" technology



TECHNICAL SPECIFICATIONS

Ingress Protection	IP20
Material	painted steel sheet
Color	light gray RAL 7035

ORDERING CODES

	Base dimensions [mm]	Height [mm]	Height [U]	Weight [kg]
8670.00/09A0C1UU-32--	550 × 570	506	9	26
8670.00/12A0C1UU-32--	550 × 570	640	12	31
8670.00/15A0C1UU-32--	550 × 570	773	15	37
8670.00/17A0C1UU-32--	550 × 570	862	17	40

- ▶ For other variants, please, contact our sales department.

MBS

The MBS wall mounted data cabinets are designed for the indoor installation of 19" technology onto a wall. The MBS data cabinets allow technology to be installed vertically, which makes them ideal for limited spaces.

- ▶ Maximum base dimensions 600 × 215 , 600 × 260, 600 × 350 mm
- ▶ Size of 3U, 4U, 6U
- ▶ Vertical placement of the technology
- ▶ Space saving
- ▶ Sliding bars for fastening 19" technology



TECHNICAL SPECIFICATIONS

Ingress Protection	IP20
Material	painted steel sheet
Color	light gray RAL 7035

ORDERING CODES

	Base dimensions [mm]	Height [mm]	Height [U]	Weight [kg]
8610.00/0300C4-----	600 × 215	535	3	18
8610.00/0400C4-----	600 × 260	535	4	20
8610.00/0600C4-----	600 × 350	535	6	22

- ▶ For other variants, please, contact our sales department.

MSS

The MSS stand data cabinets are designed for indoor installation of 19" or 21" technology (dimension of the base 800 × 600 mm and larger). A design of the self-supporting assembled frame enables an easy assembly of the data cabinet at the point of installation. The unique construction of these data cabinets also permits to reduce their weight substantially.

- ▶ Assembled frame
- ▶ Sliding supporting rails
- ▶ Removable side covers
- ▶ Possibility of assembling a set of cabinets
- ▶ Variable base dimensions (up to the depth of 1070 mm)
- ▶ Coverage degree IP 20 to EN 60529
- ▶ loading capacity data cabinets: 300 kg

TECHNICAL SPECIFICATIONS

Ingress Protection	IP20
Material	painted steel sheet
Color	light gray RAL 7035

ORDERING CODES

	Base dimensions [mm]	Height [U]	Height [mm]	Weight [kg]
8872.00/42A0CFU1-111--	600 × 600	42	2050	87
8872.00/45A0CFU1-111--	600 × 600	45	2185	93

- ▶ For other variants, please, contact our sales department.



ACCESSORIES FOR MSS

BASE The bases are provided with three breakable inlets (300 × 65 mm).

ORDERING CODES

	Suitable for	Base dimensions [mm]	Height [mm]	Color
8872.38/10A1F	MSS	600 × 600	120	RAL 7035 lt. gray
8872.38/10D1F	MSS	600 × 800	120	RAL 7035 lt. gray
8872.38/10B1F	MSS	800 × 800	120	RAL 7035 lt. gray

- ▶ For other variants, please, contact our sales department.



SPACER LEGS The spacer legs, with adjustable height and inclinable surface contact, allow for the possible unevenness of the floor.

ORDERING CODES

	Setting range [mm]	Loading capacity [kg]	No. in one pack
8A62.97/0000F	0–25	400	4

- ▶ For other variants, please, contact our sales department.



CASTORS The castors wheels make the handling of the MSS stand cabinets easier.

ORDERING CODES

	Loading capacity [kg]	No. in one pack
8A62.96/0000F	300	2 with a brake, 2 without a brake
8A62.96/0003F	600	2 with a brake, 2 without a brake

- ▶ For other variants, please, contact our sales department.



MSS 22U/55

The MSS 22U/55 is designed for the installation of 19" outdoor technology. The design of the case enables opening of side covers which considerably simplify the installation of the technology. The case may be fitted with an air-conditioning unit upon customer's request.

- ▶ enables the installation of 19" technology
- ▶ coverage degree IP 55 to EN 50102

BASIC VERSION

Base dimensions of 600 × 600 mm
Physical height of the stand: 600 mm
Physical height of the case without the stand: 1.100 mm
Installation height 22U
Side covers may be opened during installation
2 pairs of sliding vertical 19" rails
Three-point lock
Thermal insulation
Heating equipped with a thermostat
1 × ventilator (220 V) equipped with a thermostat
PG openings in the bottom
coverage degree IP 55 to EN 50102
Material: stainless steel sheet
Light-grey finish RAL 7035



TECHNICAL SPECIFICATIONS

Inputs / Outputs (quantity × range)	2 × 36–44 mm, 18 × 8–16 mm
Grommets (type and number of used grommets)	2 × PG48, 18 × PG16
Ingress Protection	IP55
Material	painted steel sheet
Color	light gray RAL 7035
Dimensions (H × W × D)	1,100 × 600 × 600 mm
Weight	95 kg

ORDERING CODES

8622.00/2200F	MSS 22U/55
---------------	------------

- ▶ For other variants, please, contact our sales department.



SAP 4 1500/2000

The outdoor data cabinet SAP 4 1500/2000 allows installation of the passive and active technology into 19" rails.

- ▶ 19" technology 20U/31U
- ▶ Hinged rack with space for documents
- ▶ Profile shelves for a second set of accumulators
- ▶ 4 lifting ears for the transport by crane
- ▶ Optional disassembling the cabinet for the transport without crane
- ▶ Door fixation in the open position (130°)
- ▶ Cooling by ventilator up to 800 m³/h
- ▶ Heating 400 W
- ▶ PLC LOGO regulation (Ethernet)
- ▶ Optional electrical and regulation equipment based on request
- ▶ DIN rails for electrical devices – 30 positions
- ▶ Gland system BST (18× 5–12 mm + 16× 13–23 mm)
- ▶ Aluzinc sheet
- ▶ Lock 2/4 points, lock semi-cylinder 31 mm
- ▶ Lighting
- ▶ Isolation – PIR plate 30 mm

BASIC VERSION

Base dimension: 700 × 700 mm
Plinth height: 150 mm
Cabinet height: 1500/2000 mm
Installation height (1 set of batteries): 20U/31U
Installation height (2 set of batteries): 12U/23U
Door locking: 2/4-point, lock semi-cylinder 31 mm
Weight: 139/165 kg
Grommet: BST system (18× 5–12 mm + 16× 13–23 mm)
Coverage degree: IP54 according to ČSN EN 60529
Material Cabinet: Aluzinc sheet metal
Colour: Epoxy-polyester RAL 7035 (light grey)
Isolation: PIR plate 30 mm thick $\lambda_0 = 0.022$ W/mK
Lifting ears: 4 lifting ears under the detachable
Operating temperature: -25 to +35 °C
Electric connection:
Covering IP20, Nominal voltage 3NPE, AC 50Hz, 400/230V, TN-C-S, Protection from dangerous voltage according to ČSN 332000-4-41ed.2: Live parts: isolation, covers, desk. Non-live parts: automatic disconnecting from power.
Additional: current protector.

TECHNICAL SPECIFICATIONS

Inputs / Outputs (quantity × range)	16× 13–23 mm, 18× 5–12 mm
Grommets (type and number of used grommets)	BST system
Ingress Protection	IP54
Material	painted steel sheet
Color	light gray RAL 7035
Dimensions (H × W × D)	1,500 × 700 × 700 mm 2,000 × 700 × 700 mm
Weight	139 / 165 kg

ORDERING CODES

On request	SAP 4 1500
On request	SAP 4 2000

- ▶ For other variants, please, contact our sales department.



SAP 4 2000



SAP 4 1500

Accessories for Data Cabinets, Data Racks

2U MOUNTING SUBRACK



The mounting subrack is designed for fastening various technological elements.

ORDERING CODES

	Height [U]	Color
8A63.00/0005F	2	Black

▶ For other variants, please, contact our sales department.

RACKS

The racks are designed for placing the technology inside the data and collocation cabinets. The loading capacity stated for rack 500 and rack 600 is applicable when 2 supporting angles are used (angle 50 or angle 400).

ORDERING CODES

	Depth [mm]	Height [U]	Loading capacity [kg]	Color	Notes	Position
8A06.10/00B5F	255	1	10	Black		–
8A29.35/00B5F	350	1	10	Black		1
8A06.00/0005F	255	2	10	Black		–
8A29.00/1005F	400	1	10	Black		–
8A07.00/0005F	400	2	10	Black		2
8A18.00/0005F	500	2	40	Black		–
8A91.00/0005F	600	2	40	Black		–
8A05.20/65B5F	650	1	40	Black	*	3
8A05.20/85B5F	850	1	40	Black	*	–

*) Only for MSS

▶ For other variants, please, contact our sales department.

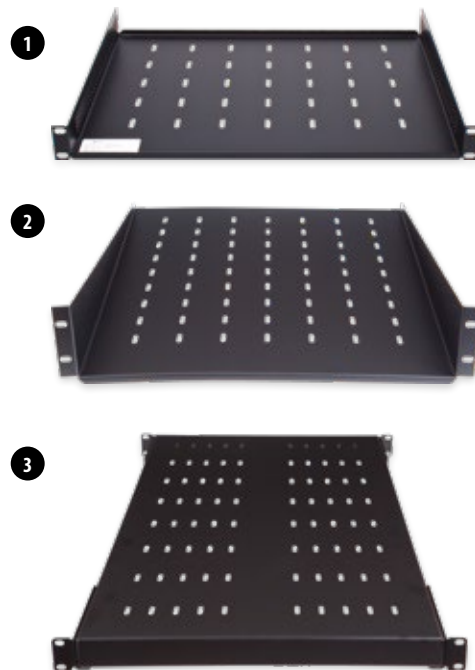

POWER SUPPLY LEADS

For the power supply of the installed technology, we offer a series of power supply leads, protected/unprotected, with different types of sockets.



ORDERING CODES

		Number of sockets	Over-voltage protection	HF screen	Power supply cable [m]	Installation to rails	Position
8A73.00/0005F	Protected extension lead	5	Yes		3	Yes / Ano	1
8A74.00/0005F	Protected extension lead	5	Yes	Yes	5	Yes / Ano	–

▶ For other variants, please, contact our sales department.

3U CIRCUIT BREAKER PANEL

The circuit breaker panel is designed for mounting electrical installation elements onto the DIN ribbon.



ORDERING CODES

	Height [U]	Color
8A30.00/0005DIN-----	3	Black

▶ For other variants, please, contact our sales department.

19" ETSI ADAPTER

This adapter allows 19" technology to be installed into the ETSI frame.



ORDERING CODES

	No. in one pack	Height [U]	Color
8821.50/0100F	2	1	Black
8873.23/0205F	2	2	Black
8A06.60/0305F	2	3	Black
8821.50/010CF	2	1	Gray
8873.23/020CF	2	2	Gray
8A06.60/030CF	2	3	Gray

► For other variants, please, contact our sales department.

CONNECTING MATERIAL



ORDERING CODES

	Description
8872.05/0000F	MSS connecting packing For connection frames of MSS
8872.12/B0A0F	Bar brackets Increase of the rigidity of MSS (for 600 × 600)
8872.12/B0B0F	Bar brackets Increase of the rigidity of MSS (for 600 × 800)
390100	M5 packing 4× screw M5, washer, M5 nut
8A62.78/0000F	M5 packing 20× screw M5, washer, M5 nut
390200	M6 packing 4× screw M6, washer, M6 nut
8A62.66/0000F	M6 packing 20× screw M6, washer, M6 nut

► For other variants, please, contact our sales department.

RANGING PANELS

The ranging panels are designed for leading cables inside the data and collocation cabinets.

- The ranging panels are designed for horizontal leading cables
- Installation on a 19" base
- Installation height 1U or 2U
- One-sided or two-sided supports
- Plastic cable rings 40/50, 40/80, 80/80



ORDERING CODES

	Height [U]	Description	Position
8A82.04/0005F	1	1U ranging panel (without cable rings) For plastic rings of 40 × 50 and 40 × 80 mm	2
8A82.05/0005F	2	2U ranging panel (without cable rings) For plastic rings of 80 × 80 mm	1
8A58.00/0105F	1	Wire channel Plastic cable rings 40/50, 40/80, 80/80	– See Cable Clips

► For other variants, please, contact our sales department.



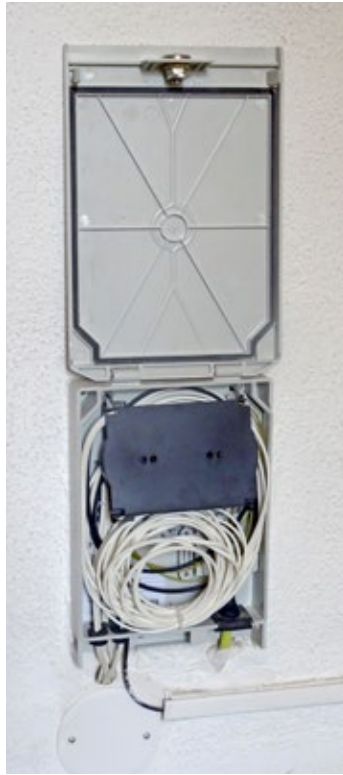



MICOS TELCOM s.r.o.

📍 Háj 365
798 12 Kralice na Hané
Czech Republic

☎ +420 582 307 511
📠 +420 582 307 688
✉ telcom@micostelcom.cz
🌐 www.micostelcom.com